

RINA LT 60

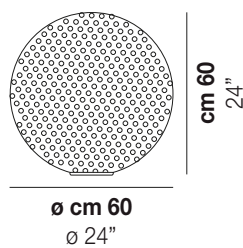

TECHNICAL DATA:



CERTIFICATIONS:



LIGHT SOURCES

3x77W 220-240 V
50/60 Hz E27

VOLUME Mc 0,39
GROSS WEIGHT Kg 20
NET WEIGHT Kg 13

[download](#)



SHADE FINISHING



BCMU

FRAME FINISHING



NI

OTHER VERSION AVAILABLE

Click on the version to go to the web version of the product



[RINA LT 16](#)



[RINA LT 25](#)

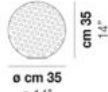

[RINA LT 35](#)

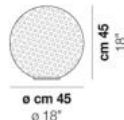

[RINA LT 45](#)

RINA LT 45

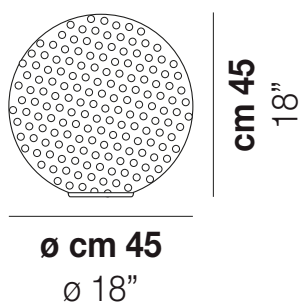

TECHNICAL DATA:



CERTIFICATIONS:



LIGHT SOURCES

1x77W 220-240 V
50/60 Hz E27

VOLUME Mc 0,23
GROSS WEIGHT Kg 11
NET WEIGHT Kg 9

[download](#)



SHADE FINISHING



BCMU

FRAME FINISHING



NI

OTHER VERSION AVAILABLE

Click on the version to go to the web version of the product



[RINA LT 16](#)



[RINA LT 25](#)

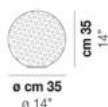

[RINA LT 35](#)

RINA LT 35

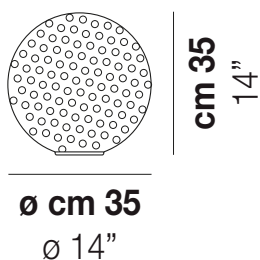

\varnothing cm 35
 \varnothing 14"

TECHNICAL DATA:

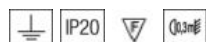

CERTIFICATIONS:



LIGHT SOURCES

1x77W 220-240 V E27
50/60 Hz

VOLUME Mc 0,1
 GROSS WEIGHT Kg 7
 NET WEIGHT Kg 4

[download](#)



SHADE FINISHING



BCMU

FRAME FINISHING



NI

OTHER VERSION AVAILABLE

Click on the version to go to the web version of the product



RINA LT 16



RINA LT 25

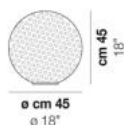

RINA LT 45

RINA LT 25

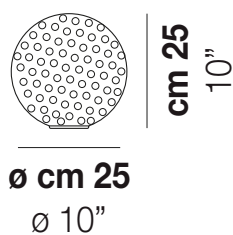

TECHNICAL DATA:



CERTIFICATIONS:



LIGHT SOURCES

1x77W 220-240 V E27
50/60 Hz

VOLUME Mc 0,07
GROSS WEIGHT Kg 3
NET WEIGHT Kg 2

[download](#)



SHADE FINISHING



BCMU

FRAME FINISHING



NI

OTHER VERSION AVAILABLE

Click on the version to go to the web version of the product



[RINA LT 16](#)

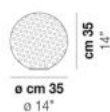

[RINA LT 35](#)

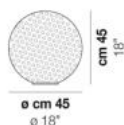

[RINA LT 45](#)

RINA LT 16

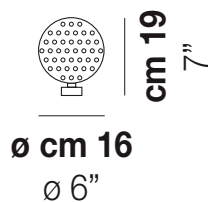

TECHNICAL DATA:



CERTIFICATIONS:



LIGHT SOURCES

1x60W 220-240 V
50/60 Hz G9

VOLUME Mc 0,04
 GROSS WEIGHT Kg 3
 NET WEIGHT Kg 2

[download](#)



SHADE FINISHING



BCMU

FRAME FINISHING



NI

OTHER VERSION AVAILABLE

Click on the version to go to the web version of the product

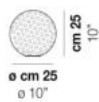

RINA LT 25

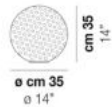

RINA LT 35

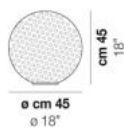

RINA LT 45