

MORIS
Design Vistosi

MORIS PL 30



Moris is Available in three sizes. It can be placed both as a ceiling or wall lamp. The lenticular shape of the satin finish blown glass helps to maximize the light output.

MORIS PL 30

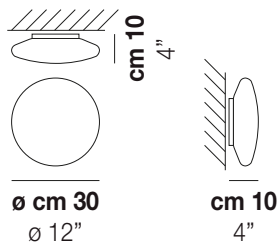



TECHNICAL DATA:



CERTIFICATIONS:



LIGHT SOURCES

	1x77w	220-240 V 50/60 Hz	E27
	1x12 W	24 V	Led 2700 K 12 W 24 V 1700 lm DIM2 Phase Cut
	1x12 W	24 V	Led 3000 K 12 W 24 V 1700 lm DIM3 0-10V, Push

VOLUME	Mc 0,03
GROSS WEIGHT	Kg 3
NET WEIGHT	Kg 2

download



SHADE FINISHING



BCST

FRAME FINISHING



BC

OTHER VERSION AVAILABLE

Click on the version to go to the web version of the product

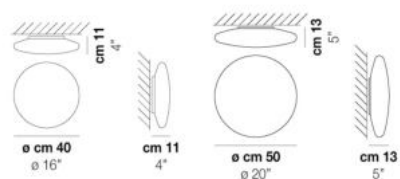

MORIS PP 40

MORIS PP 50

MORIS
Design Vistosi

MORIS PL 30



Moris is Available in three sizes. It can be placed both as a ceiling or wall lamp. The lenticular shape of the satin finish blown glass helps to maximize the light output.

MORIS PL 30

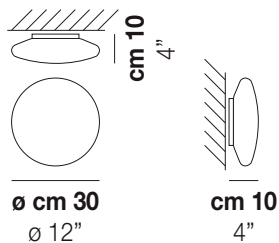



TECHNICAL DATA:



CERTIFICATIONS:



LIGHT SOURCES

	1x77w	220-240 V 50/60 Hz	E27
	1x12 W	24 V	Led 2700 K 12 W 24 V 1700 lm DIM2 Phase Cut
	1x12 W	24 V	Led 3000 K 12 W 24 V 1700 lm DIM3 0-10V, Push

VOLUME	Mc 0,03
GROSS WEIGHT	Kg 3
NET WEIGHT	Kg 2

download



SHADE FINISHING



BCST

FRAME FINISHING



BC

OTHER VERSION AVAILABLE

Click on the version to go to the web version of the product

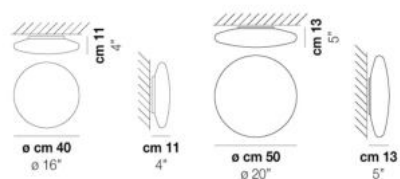

MORIS PP 40

MORIS PP 50

MORIS

Design Vistosi

MORIS PL 30



Moris is Available in three sizes. It can be placed both as a ceiling or wall lamp. The lenticular shape of the satin finish blown glass helps to maximize the light output.

MORIS PL 30

TECHNICAL DATA:



CERTIFICATIONS:

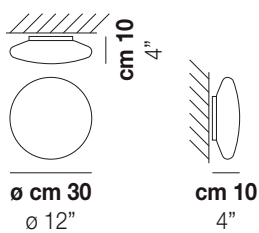

VOLUME	Mc 0
GROSS WEIGHT	Kg 3
NET WEIGHT	Kg 2

download



SHADE FINISHING



BCST

FRAME FINISHING



BC

OTHER VERSION AVAILABLE

Click on the version to go to the web version of the product

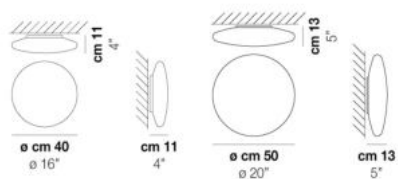

MORIS PP 40

MORIS PP 50

MORIS
Design Vistosi

MORIS PL 30



Moris is Available in three sizes. It can be placed both as a ceiling or wall lamp. The lenticular shape of the satin finish blown glass helps to maximize the light output.

MORIS PL 30

TECHNICAL DATA:



CERTIFICATIONS:

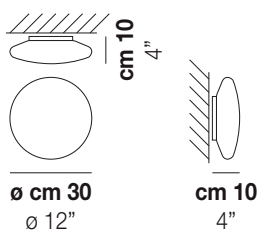

VOLUME	Mc 0,03
GROSS WEIGHT	Kg 3
NET WEIGHT	Kg 2

download



SHADE FINISHING



BCST

FRAME FINISHING



BC

OTHER VERSION AVAILABLE

Click on the version to go to the web version of the product

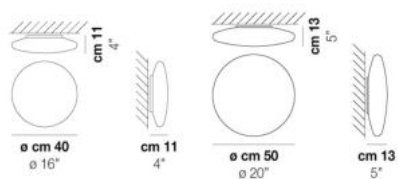

MORIS PP 40

MORIS PP 50

MORIS

Design Vistosi

MORIS PL 30



Moris is Available in three sizes. It can be placed both as a ceiling or wall lamp. The lenticular shape of the satin finish blown glass helps to maximize the light output.

MORIS PL 30

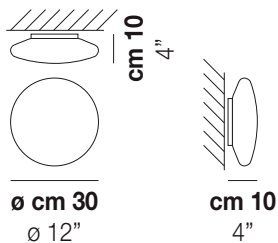



TECHNICAL DATA:



CERTIFICATIONS:



LIGHT SOURCES

	1x77w	220-240 V 50/60 Hz	E27
	1x12 W	24 V	Led 2700 K 12 W 24 V 1700 lm DIM2 Phase Cut
	1x12 W	24 V	Led 3000 K 12 W 24 V 1700 lm DIM3 0-10V, Push

VOLUME	Mc 0,03
GROSS WEIGHT	Kg 3
NET WEIGHT	Kg 2

download



SHADE FINISHING



BCST

FRAME FINISHING



BC

OTHER VERSION AVAILABLE

Click on the version to go to the web version of the product

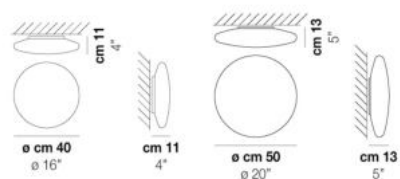

MORIS PP 40

MORIS PP 50

MORIS

Design Vistosi

MORIS PL 40



Moris is Available in three sizes. It can be placed both as a ceiling or wall lamp. The lenticular shape of the satin finish blown glass helps to maximize the light output.

MORIS PL 40

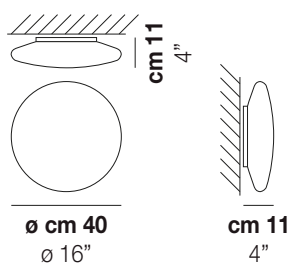

TECHNICAL DATA:

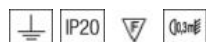

CERTIFICATIONS:



LIGHT SOURCES

1x77w 220-240 V 50/60 Hz E27

 1x19 W 39 V

Led 3000 K 19 W 39 V 2850 lm DIM3 0-10V, Push

VOLUME Mc 0,05
GROSS WEIGHT Kg 5
NET WEIGHT Kg 3

[download](#)



SHADE FINISHING



BCST

FRAME FINISHING



BC

OTHER VERSION AVAILABLE

Click on the version to go to the web version of the product

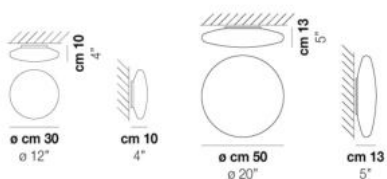

MORIS PP 30

MORIS PP 50

MORIS

Design Vistosi

MORIS PL 40



Moris is Available in three sizes. It can be placed both as a ceiling or wall lamp. The lenticular shape of the satin finish blown glass helps to maximize the light output.

MORIS PL 40

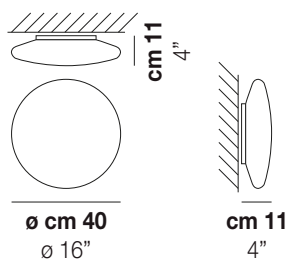

TECHNICAL DATA:



CERTIFICATIONS:



VOLUME	Mc 0
GROSS WEIGHT	Kg 5
NET WEIGHT	Kg 3

download



SHADE FINISHING



BCST

FRAME FINISHING



BC

OTHER VERSION AVAILABLE

Click on the version to go to the web version of the product

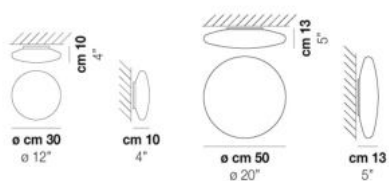

MORIS PP 30

MORIS PP 50

MORIS

Design Vistosi

MORIS PL 40



Moris is Available in three sizes. It can be placed both as a ceiling or wall lamp. The lenticular shape of the satin finish blown glass helps to maximize the light output.

MORIS PL 40

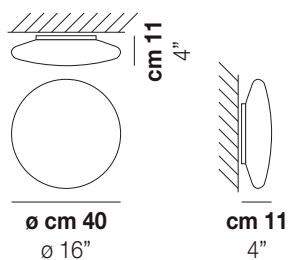

TECHNICAL DATA:



CERTIFICATIONS:



VOLUME	Mc 0
GROSS WEIGHT	Kg 5
NET WEIGHT	Kg 3

download



SHADE FINISHING



BCST

FRAME FINISHING



BC

OTHER VERSION AVAILABLE

Click on the version to go to the web version of the product

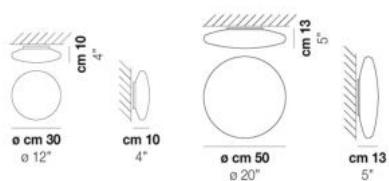

MORIS PP 30

MORIS PP 50

MORIS

Design Vistosi

MORIS PL 40



Moris is Available in three sizes. It can be placed both as a ceiling or wall lamp. The lenticular shape of the satin finish blown glass helps to maximize the light output.

MORIS PL 40

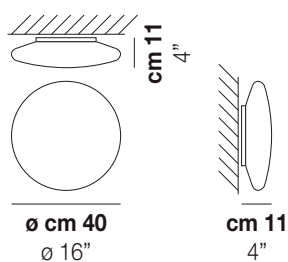

TECHNICAL DATA:



CERTIFICATIONS:



VOLUME	Mc 0,05
GROSS WEIGHT	Kg 5
NET WEIGHT	Kg 3

download



SHADE FINISHING



BCST

FRAME FINISHING



BC

OTHER VERSION AVAILABLE

Click on the version to go to the web version of the product

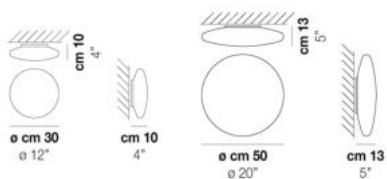

MORIS PP 30

MORIS PP 50

MORIS
Design Vistosi

MORIS PL 40



Moris is Available in three sizes. It can be placed both as a ceiling or wall lamp. The lenticular shape of the satin finish blown glass helps to maximize the light output.

MORIS PL 40

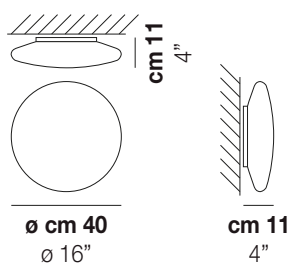

TECHNICAL DATA:



CERTIFICATIONS:



LIGHT SOURCES

1x77w 220-240 V 50/60 Hz E27



1x19 W 39 V

Led 3000 K 19 W 39 V 2850 lm DIM3 0-10V, Push

VOLUME Mc 0,05
GROSS WEIGHT Kg 5
NET WEIGHT Kg 3

download



SHADE FINISHING



BCST

FRAME FINISHING



BC

OTHER VERSION AVAILABLE

Click on the version to go to the web version of the product

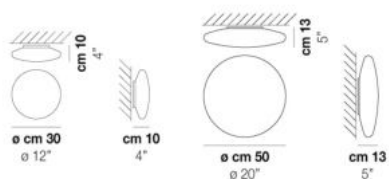

MORIS PP 30

MORIS PP 50

MORIS

Design Vistosi

MORIS PL 50



Moris is Available in three sizes. It can be placed both as a ceiling or wall lamp. The lenticular shape of the satin finish blown glass helps to maximize the light output.

MORIS PL 50

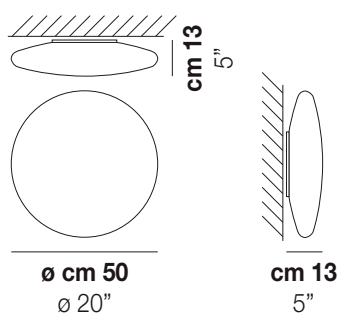

TECHNICAL DATA:



CERTIFICATIONS:



LIGHT SOURCES

2x77w 220-240 V 50/60 Hz E27

LED 3000K DIM2 1x19 W 39 V

Led 3000 K 19 W 39 V 2850 lm DIM2 Phase Cut

LED 3000K DIM3 1x19 W 39 V

Led 3000 K 19 W 39 V 2850 lm DIM3 0-10V, Push

VOLUME Mc 0,13

GROSS WEIGHT Kg 9

NET WEIGHT Kg 6

download



SHADE FINISHING



BCST

FRAME FINISHING



BC

OTHER VERSION AVAILABLE

Click on the version to go to the web version of the product

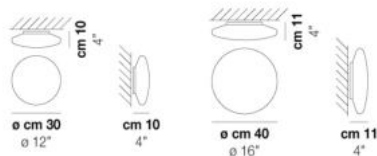

MORIS PP 30

MORIS PP 40

MORIS

Design Vistosi

MORIS PL 50



Moris is Available in three sizes. It can be placed both as a ceiling or wall lamp. The lenticular shape of the satin finish blown glass helps to maximize the light output.

MORIS PL 50

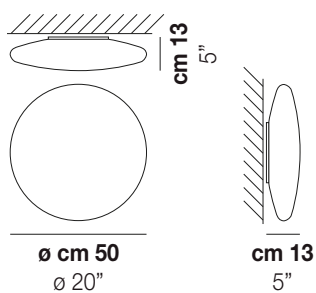

TECHNICAL DATA:



CERTIFICATIONS:



VOLUME	Mc 0
GROSS WEIGHT	Kg 9
NET WEIGHT	Kg 6

download



SHADE FINISHING



BCST

FRAME FINISHING



BC

OTHER VERSION AVAILABLE

Click on the version to go to the web version of the product

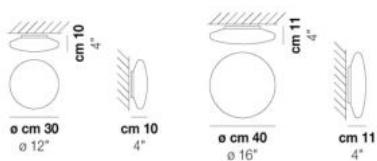

MORIS PP 30

MORIS PP 40