

DAMASCO

Design Paolo Crepax

DAMASCO SP C



Due to its versatility, one of our most successful series that has been developed and extended during the years with new versions. It is produced with the bozzolo technique that consists in applying threads of molten glass that create an organic texture.

DAMASCO SP C

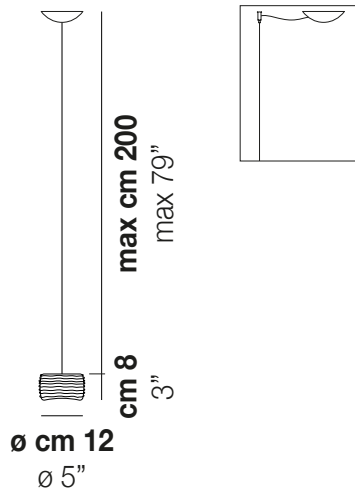

TECHNICAL DATA:



CERTIFICATIONS:



LIGHT SOURCES

1x60W 220-240 V G9
50/60 Hz

VOLUME Mc 0,01
GROSS WEIGHT Kg 1,5
NET WEIGHT Kg 1

[download](#)



SHADE FINISHING

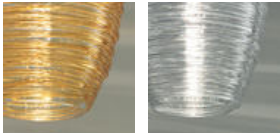

CRAM

CRCR

FRAME FINISHING



NI

OTHER VERSION AVAILABLE

Click on the version to go to the web version of the product

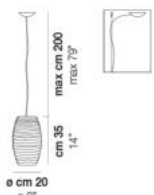

DAMAS SP G

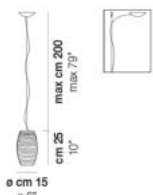

DAMAS SP M

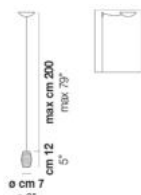

DAMAS SP P

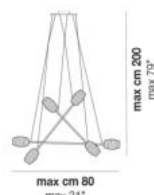

DAMAS SP 6 P

DAMASCO

Design Paolo Crepax

DAMASCO SP C



Due to its versatility, one of our most successful series that has been developed and extended during the years with new versions. It is produced with the bozzolo technique that consists in applying threads of molten glass that create an organic texture.

DAMASCO SP C

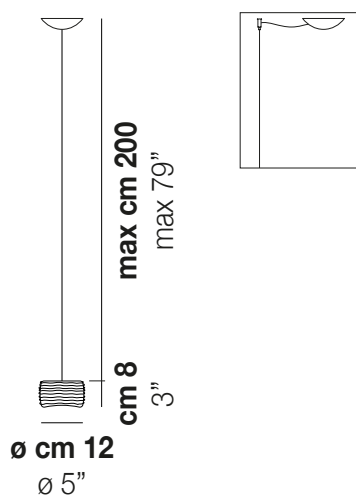

TECHNICAL DATA:



CERTIFICATIONS:



VOLUME Mc 0
GROSS WEIGHT Kg 1,5
NET WEIGHT Kg 1

download



SHADE FINISHING

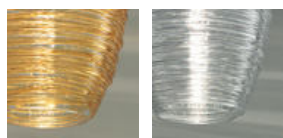

CRAM

CRCR

FRAME FINISHING



NI

OTHER VERSION AVAILABLE

Click on the version to go to the web version of the product

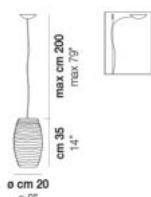

DAMAS SP G

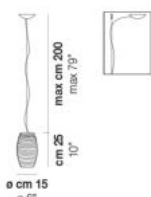

DAMAS SP M

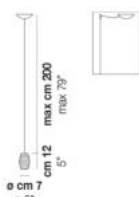

DAMAS SP P

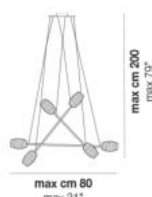

DAMAS SP 6 P

DAMASCO

Design Paolo Crepax

DAMASCO SP C



Due to its versatility, one of our most successful series that has been developed and extended during the years with new versions. It is produced with the bozzolo technique that consists in applying threads of molten glass that create an organic texture.

DAMASCO SP C

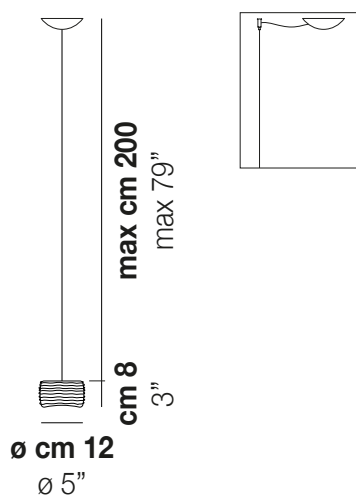

TECHNICAL DATA:



CERTIFICATIONS:



VOLUME Mc 0
GROSS WEIGHT Kg 1,5
NET WEIGHT Kg 1

download



SHADE FINISHING

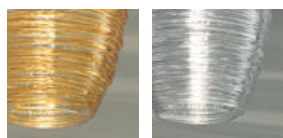

CRAM

CRCR

FRAME FINISHING



NI

OTHER VERSION AVAILABLE

Click on the version to go to the web version of the product

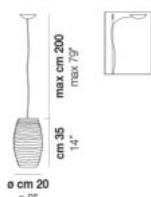

DAMAS SP G

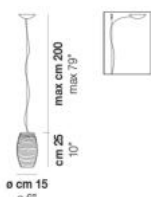

DAMAS SP M

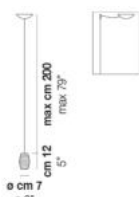

DAMAS SP P

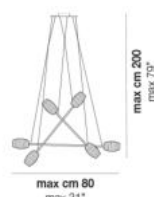

DAMAS SP 6 P

DAMASCO

Design Paolo Crepax

DAMASCO SP C



Due to its versatility, one of our most successful series that has been developed and extended during the years with new versions. It is produced with the bozzolo technique that consists in applying threads of molten glass that create an organic texture.

DAMASCO SP C

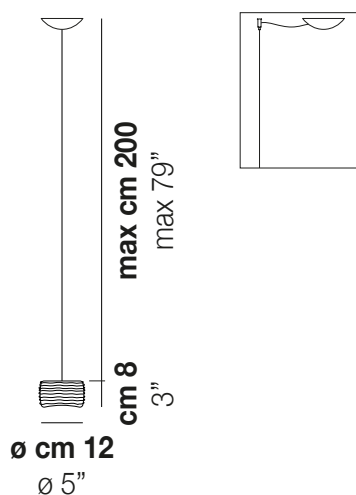

TECHNICAL DATA:



CERTIFICATIONS:



VOLUME Mc 0
GROSS WEIGHT Kg 1,5
NET WEIGHT Kg 1

download



SHADE FINISHING

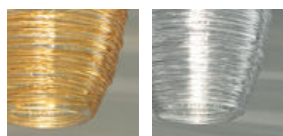

CRAM

CRCR

FRAME FINISHING



NI

OTHER VERSION AVAILABLE

Click on the version to go to the web version of the product



DAMAS SP G

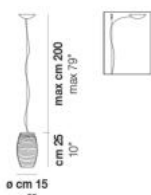

DAMAS SP M

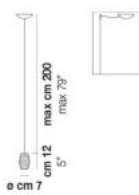

DAMAS SP P

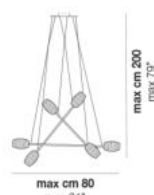

DAMAS SP 6 P

DAMASCO

Design Paolo Crepax

DAMASCO SP C



Due to its versatility, one of our most successful series that has been developed and extended during the years with new versions. It is produced with the bozzolo technique that consists in applying threads of molten glass that create an organic texture.

DAMASCO SP C

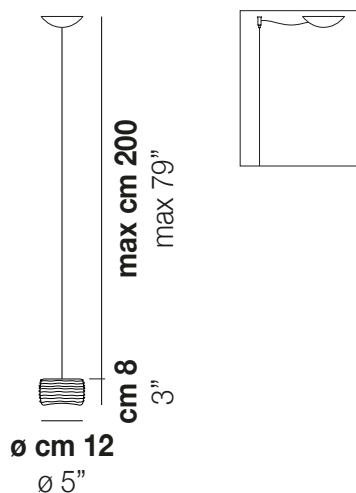

TECHNICAL DATA:



CERTIFICATIONS:



VOLUME Mc 0,01
GROSS WEIGHT Kg 1,5
NET WEIGHT Kg 1

download



SHADE FINISHING

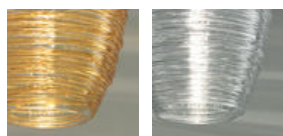

CRAM

CRCR

FRAME FINISHING



NI

OTHER VERSION AVAILABLE

Click on the version to go to the web version of the product

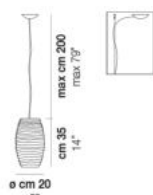

DAMAS SP G

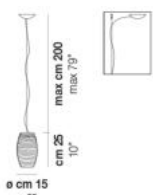

DAMAS SP M

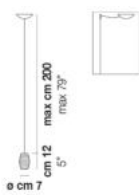

DAMAS SP P

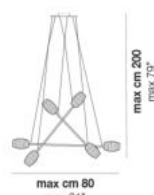

DAMAS SP 6 P

DAMASCO

Design Paolo Crepax

DAMASCO SP G



Due to its versatility, one of our most successful series that has been developed and extended during the years with new versions. It is produced with the bozzolo technique that consists in applying threads of molten glass that create an organic texture.

DAMASCO SP G

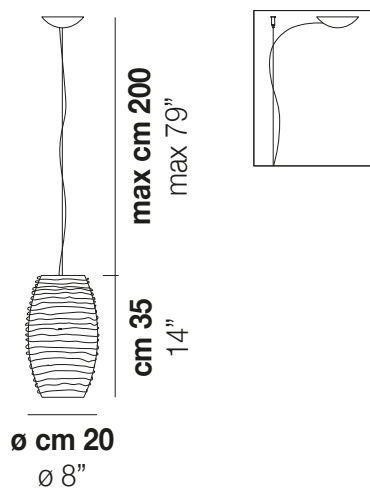

TECHNICAL DATA:



CERTIFICATIONS:



LIGHT SOURCES

1x77W 220-240 V 50/60 Hz E27

VOLUME Mc 0,08
GROSS WEIGHT Kg 8
NET WEIGHT Kg 5

[download](#)



SHADE FINISHING

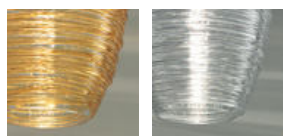

CRAM

CRCR

FRAME FINISHING



NI

OTHER VERSION AVAILABLE

Click on the version to go to the web version of the product



DAMAS SP C



DAMAS SP M



DAMAS SP P

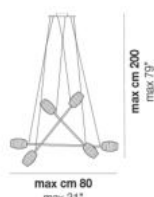

DAMAS SP 6 P

DAMASCO

Design Paolo Crepax

DAMASCO SP G



Due to its versatility, one of our most successful series that has been developed and extended during the years with new versions. It is produced with the bozzolo technique that consists in applying threads of molten glass that create an organic texture.

DAMASCO SP G

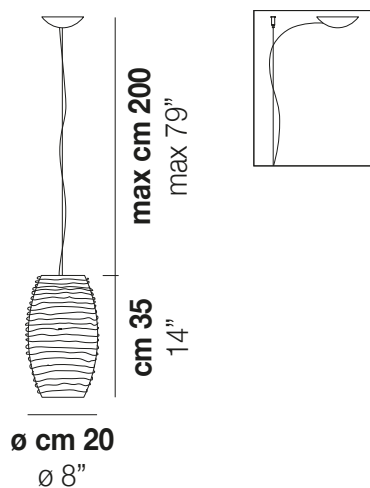

TECHNICAL DATA:



CERTIFICATIONS:



VOLUME Mc 0
GROSS WEIGHT Kg 8
NET WEIGHT Kg 5

download



SHADE FINISHING

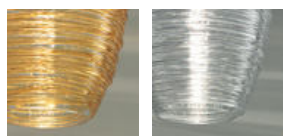

CRAM

CRCR

FRAME FINISHING



NI

OTHER VERSION AVAILABLE

Click on the version to go to the web version of the product

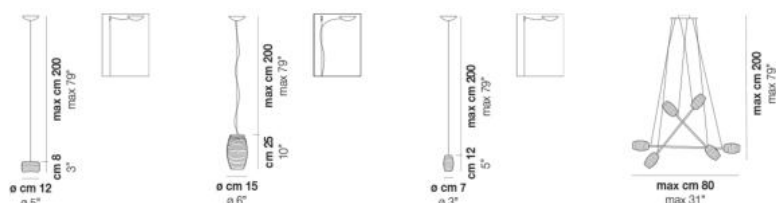

DAMAS SP C

DAMAS SP M

DAMAS SP P

DAMAS SP 6 P

DAMASCO

Design Paolo Crepax

DAMASCO SP G



Due to its versatility, one of our most successful series that has been developed and extended during the years with new versions. It is produced with the bozzolo technique that consists in applying threads of molten glass that create an organic texture.

DAMASCO SP G

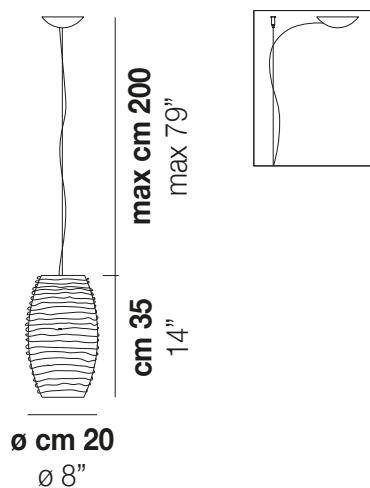

TECHNICAL DATA:



CERTIFICATIONS:



VOLUME Mc 0
GROSS WEIGHT Kg 8
NET WEIGHT Kg 5

download



SHADE FINISHING

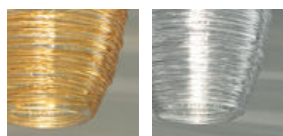

CRAM

CRCR

FRAME FINISHING



NI

OTHER VERSION AVAILABLE

Click on the version to go to the web version of the product

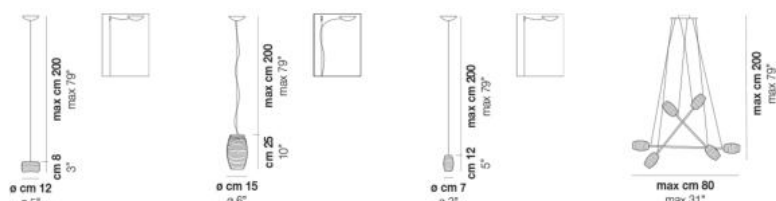

DAMAS SP C

DAMAS SP M

DAMAS SP P

DAMAS SP 6 P

DAMASCO

Design Paolo Crepax

DAMASCO SP G



Due to its versatility, one of our most successful series that has been developed and extended during the years with new versions. It is produced with the bozzolo technique that consists in applying threads of molten glass that create an organic texture.

DAMASCO SP G

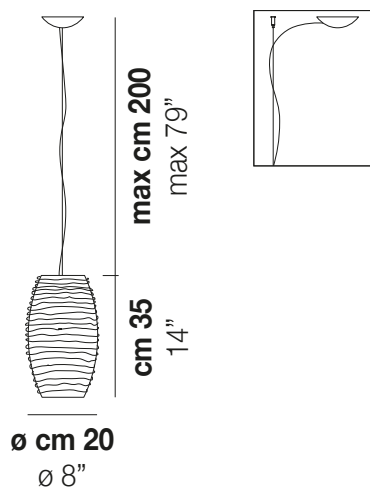

TECHNICAL DATA:



CERTIFICATIONS:



VOLUME Mc 0
GROSS WEIGHT Kg 8
NET WEIGHT Kg 5

download



SHADE FINISHING

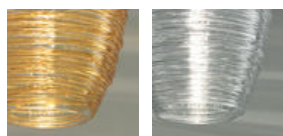

CRAM

CRCR

FRAME FINISHING



NI

OTHER VERSION AVAILABLE

Click on the version to go to the web version of the product

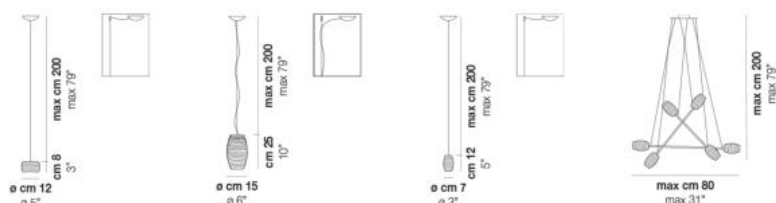

DAMAS SP C

DAMAS SP M

DAMAS SP P

DAMAS SP 6 P

DAMASCO

Design Paolo Crepax

DAMASCO SP G



Due to its versatility, one of our most successful series that has been developed and extended during the years with new versions. It is produced with the bozzolo technique that consists in applying threads of molten glass that create an organic texture.

DAMASCO SP G

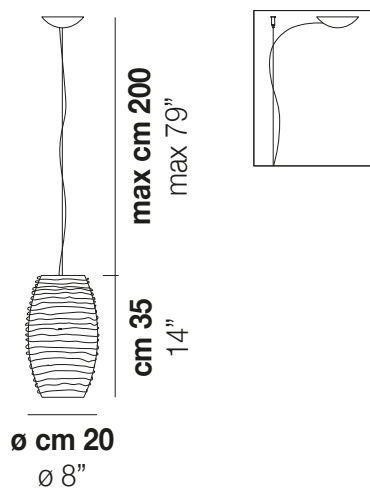

TECHNICAL DATA:



CERTIFICATIONS:



VOLUME Mc 0
GROSS WEIGHT Kg 8
NET WEIGHT Kg 5

download



SHADE FINISHING

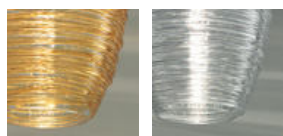

CRAM

CRCR

FRAME FINISHING



NI

OTHER VERSION AVAILABLE

Click on the version to go to the web version of the product



DAMAS SP C



DAMAS SP M



DAMAS SP P

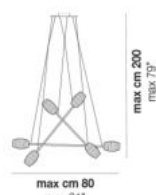

DAMAS SP 6 P

DAMASCO

Design Paolo Crepax

DAMASCO SP M



Due to its versatility, one of our most successful series that has been developed and extended during the years with new versions. It is produced with the bozzolo technique that consists in applying threads of molten glass that create an organic texture.

DAMASCO SP M

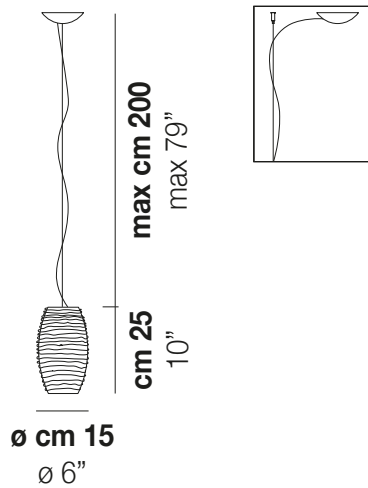

TECHNICAL DATA:



CERTIFICATIONS:



LIGHT SOURCES

1x77W 220-240 V
50/60 Hz E27

VOLUME Mc 0,08
GROSS WEIGHT Kg 8
NET WEIGHT Kg 5

[download](#)



SHADE FINISHING

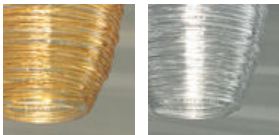

CRAM

CRCR

FRAME FINISHING



NI

OTHER VERSION AVAILABLE

Click on the version to go to the web version of the product

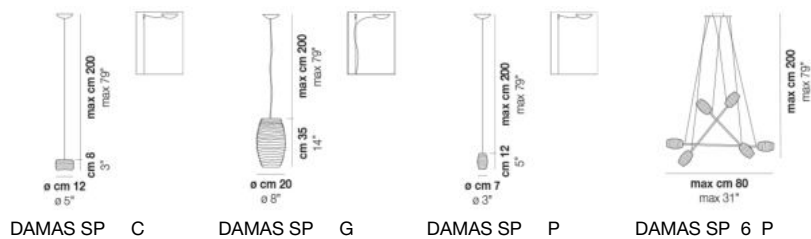

DAMAS SP C

DAMAS SP G

DAMAS SP P

DAMAS SP 6 P

DAMASCO

Design Paolo Crepax

DAMASCO SP M



Due to its versatility, one of our most successful series that has been developed and extended during the years with new versions. It is produced with the bozzolo technique that consists in applying threads of molten glass that create an organic texture.

DAMASCO SP M

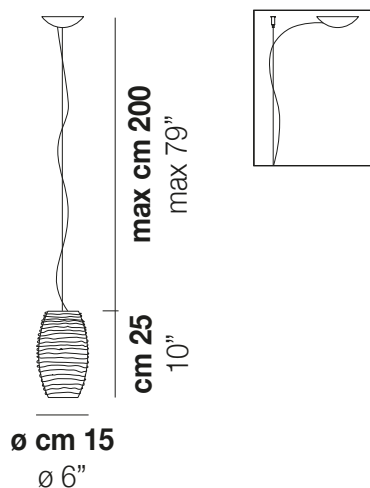

TECHNICAL DATA:



CERTIFICATIONS:



LIGHT SOURCES

1x77W 220-240 V E27
50/60 Hz

VOLUME Mc 0
GROSS WEIGHT Kg 8
NET WEIGHT Kg 5

[download](#)



SHADE FINISHING

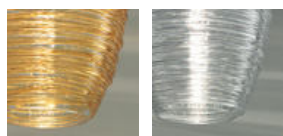

CRAM

CRCR

FRAME FINISHING



NI

OTHER VERSION AVAILABLE

Click on the version to go to the web version of the product

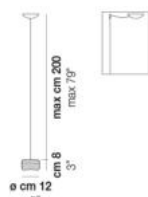

DAMAS SP C

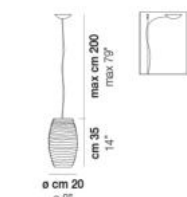

DAMAS SP G

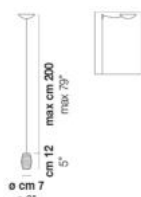

DAMAS SP P

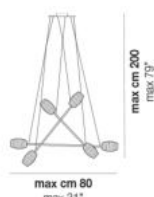

DAMAS SP 6 P