

design — Chiara Andreatti



Ropu, 888/CQR-IN
pouf \ *pouf*

Dalle rimembranze esotiche, Ropu si distingue per la bordatura intrecciata in cordino di cuoio, nella versione per interni, o nautico, per gli esterni, che corre lungo il perimetro creando una cornice per top in marmo, vetro retroverniciato e hpl oppure soffici cuscini con profili a coda di topo. Con base a quattro gambe in metallo, la collezione è disponibile nella versione tavolino basso, con piano rettangolare, o alto, con piano tondo, e pouf rettangolare da abbinare in libere composizioni.

From exotic remembrances, Ropu stands out for its sophisticated woven border in hide rope, for indoor spaces, or nautical rope, for the outdoor, running along the perimeter structure creating a frame for marble, back-painted glass and ceramic tops or soft cushions with mouse-tail cord profiles. With a four-legged metal base, the collection consists of a low coffee table with rectangular top, or a high coffee table with round top, and a rectangular pouf that can be combined in the desired compositions.

Informazioni tecniche \ *Technical information*

Descrizione tecnica \ *Technical description*



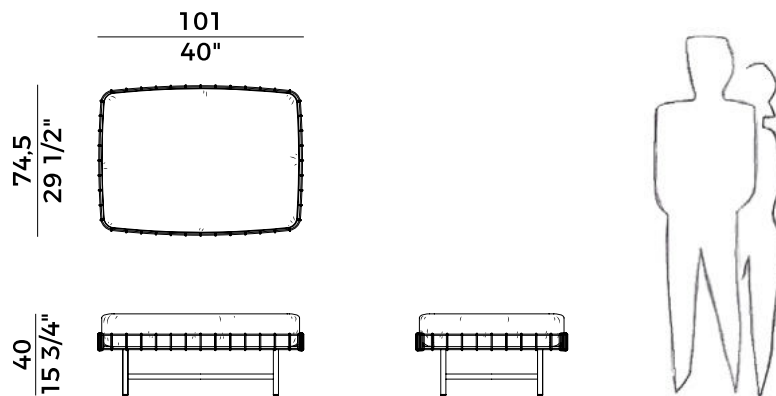

Pouf rettangolare, con struttura in metallo verniciato antracite goffrato. Cornice con intreccio in cordino di cuoio o in cordino "Gassa" testa di moro. Cuscino sfoderabile.

Rectangular pouf, with anthracite embossed lacquered metal structure. Frame with plaited hide leather rope or dark brown "Gassa" rope. Cushion with removable covers.

Dimensioni \ *Dimensions*



Consumi stoffe \ *Fabric and leather requirements*

FABRIC / LEATHER REQUIREMENTS				FABRIC / LEATHER REQUIREMENTS			
		x1	x2			x1	x2
	H 140	ml 2.00	ml 4.00		H 140	yd 2.20	yd 4.40
	LEATHER	m ² 3.00			LEATHER	ft ² 33	

Finiture \ *Finishes*

Finiture struttura \

Frame finishes

Metallo \ *Metal*

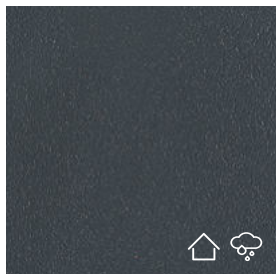

Verniciato Antracite Goffrato \
Anthracite Embossed Lacquered

Finiture intreccio \

Weaving finishes

Cordino \ *Rope*



Gassa Testa di Moro \
Gassa Dark Brown



Cuoio \
Hide Leather

Rivestimenti \

Coverings

Tessuto, ecopelle, pelle \ *Fabric, eco-leather, leather*

**Collezione Ropu **
Ropu collection

Collezione di tavolini e pouf, con struttura in metallo verniciato antracite gofrato. Cornice con intreccio in cordino di cuoio o in cordino "Gassa" testa di moro. Tavolini con top rettangolare o tondo in vetro retro verniciato nero, grès porcellanato, HPL o marmo. Pouf rettangolare con cuscino sfoderabile.

Collection of coffee tables and pouf, with anthracite embossed lacquered metal structure. Frame with plaited hide leather rope or dark brown "Gassa" rope. Coffee tables with rectangular or round top available in black back-painted glass, laminated porcelain, HPL or marble. Rectangular pouf with cushion with removable covers.

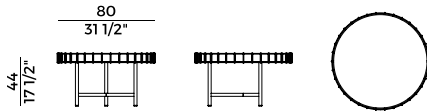

888/TBC
tavolino \ coffee table

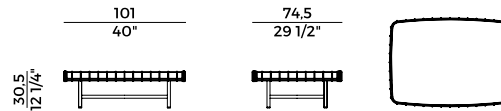

888/TBR
tavolino \ coffee table

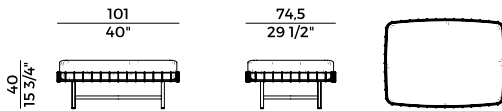

888/CQR-IN
pouf \ pouf