



Tavolo chiuso



Tavolo allungato

Diva, 775/TC1
tavolo \ table

La collezione Diva è composta da tavolo allungabile e contenitore nei quali è vigorosa la presenza del legno di rovere che si stempera nella delicatezza del disegno. La madia soddisfa ogni esigenza di contenimento.

The Diva collection is composed by an extendable table and a storage unit, characterized by the vigorous presence of oak wood, which tones down in the delicate design. The sophisticated sideboard satisfies every storage requirement.

Informazioni tecniche \ *Technical information*

Descrizione tecnica \ *Technical description*

Tavolo estensibile a base centrale con struttura in rovere e metallo. Piano tondo. Finiture di collezione.

Extendable table with central base and frame in oak and metal. Round top. Materials as per collection.

Dimensioni \ *Dimensions*

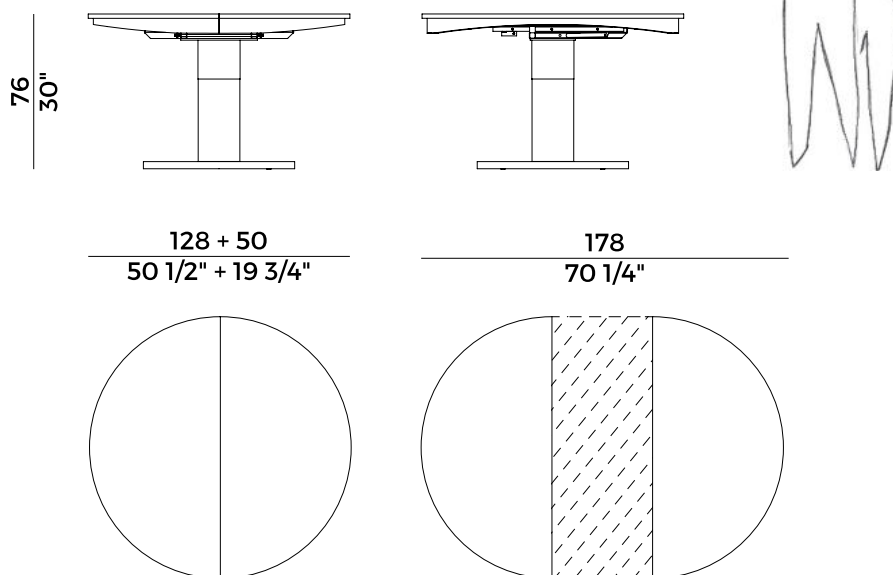

PACKAGING

3 crt = m³ 0.35

gross weight - Kg 110

Finiture \ *Finishes*

Finiture base e piano \

base and top finishes

Rovere \ *Oak*



UH
Tinto Anilina Beige \
Beige Aniline Stained

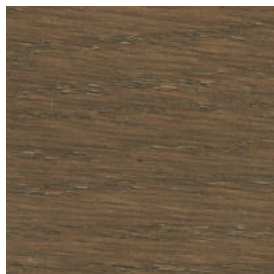

UC
Tinto Biscotto \
Biscuit Stained

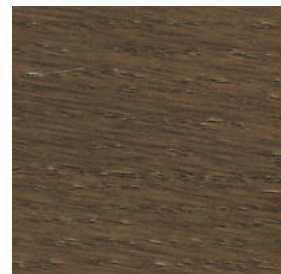

TD
Tinto Moka \
Moka Stained

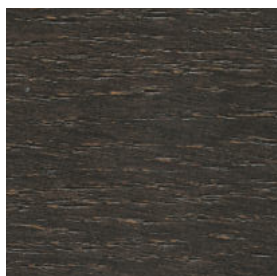

TA
Tinto Grigio Plumbeo \
Dark Grey Stained

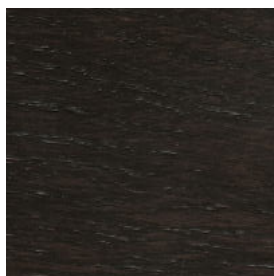

TY
Tinto Wengé \
Wengé Stained



RQ
Tinto Carbone \
Carbon Stained

Colonna e bordo base \

column and edge base

Metallo \ *Metal*

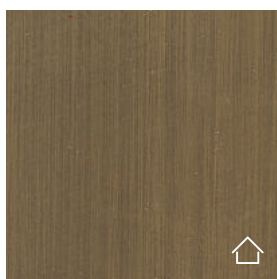

Ottone Brunito \
Bronzed Brass

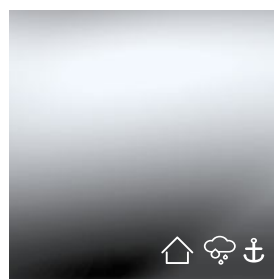

Inox Lucido Aisi 316 \
Inox Aisi 316 Polish

Collezione Diva \
Diva collection

Collezione di arredi composta da tavoli estensibili e contenitore. Tavolo estensibile a base centrale con struttura in rovere e metallo. Disponibile in versione tonda e ovale. Contenitore con due ante laterali curvate e sei cassetti centrali con sistema di apertura push&pull. Struttura in rovere. Basamento in massello di legno di rovere. Finiture di collezione.

Collection of furnishings composed of extendable tables and cabinet. Extendable table with central base and frame in oak and metal. Available in round and oval version. Cabinet with two curved side doors and six central drawers with push&pull opening system. Oak frame. Base in solid oak. Materials as per collection.

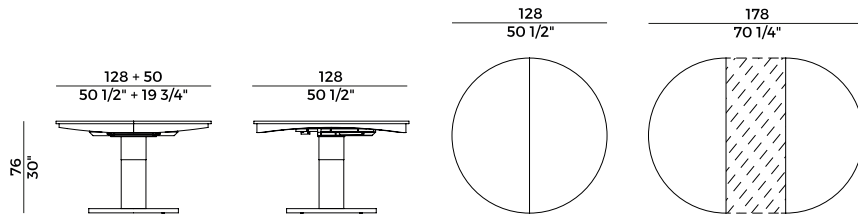

775/TC1
tavolo estensibile \ extendable table

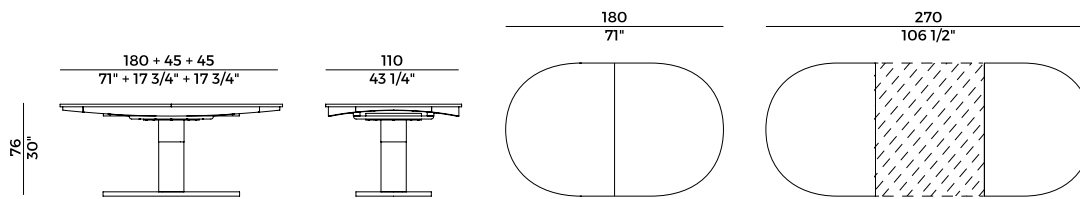

775/TO2
tavolo estensibile \ extendable table

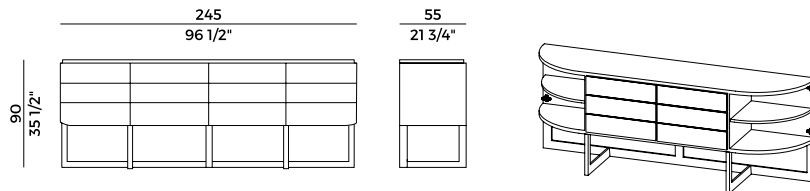

775/M
credenza \ sideboard

design — Alexander Lorenz



Tavolo chiuso



Tavolo allungato

Diva, 775/TO2
tavolo \ table

La collezione Diva è composta da tavolo allungabile e contenitore nei quali è vigorosa la presenza del legno di rovere che si stempera nella delicatezza del disegno. La madia soddisfa ogni esigenza di contenimento.

The Diva collection is composed by an extendable table and a storage unit, characterized by the vigorous presence of oak wood, which tones down in the delicate design. The sophisticated sideboard satisfies every storage requirement.

Informazioni tecniche \ *Technical information*

Descrizione tecnica \ *Technical description*

Tavolo estensibile a base centrale con struttura in rovere e metallo. Piano ovale. Finiture di collezione.

Extendable table with central base and frame in oak and metal. Oval top. Materials as per collection.

Dimensioni \ *Dimensions*

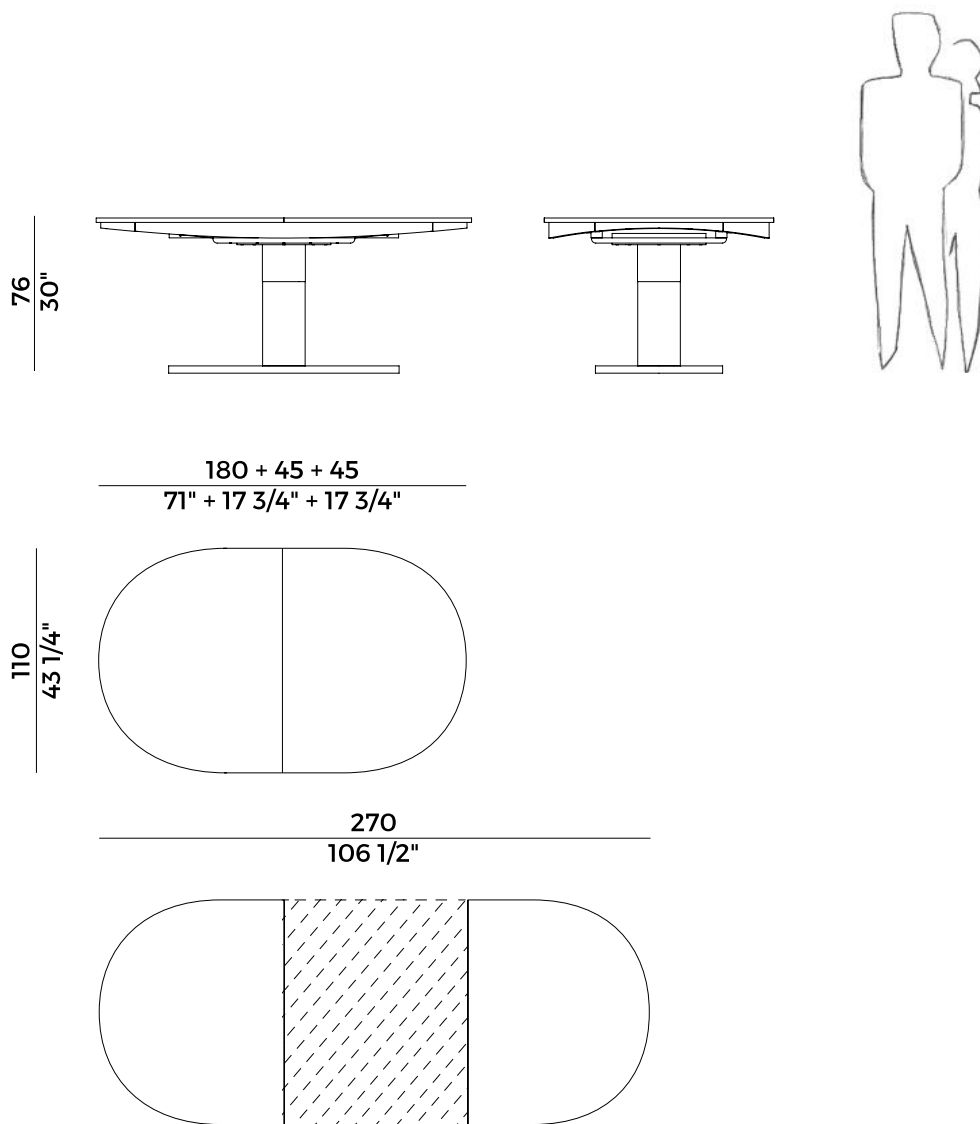

PACKAGING

3 crt = m³ 0.55

gross weight - Kg 137

Finiture \ *Finishes*

Finiture base e piano \

base and top finishes

Rovere \ *Oak*



UH
Tinto Anilina Beige \
Beige Aniline Stained



UC
Tinto Biscotto \
Biscuit Stained

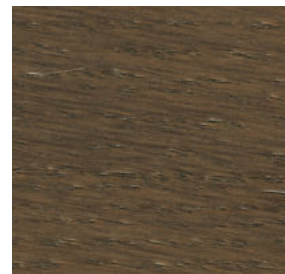

TD
Tinto Moka \
Moka Stained

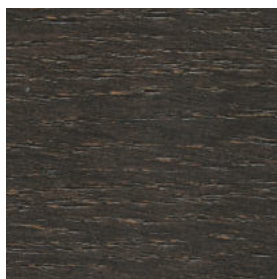

TA
Tinto Grigio Plumbeo \
Dark Grey Stained

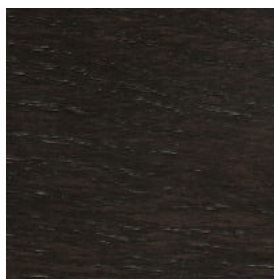

TY
Tinto Wengé \
Wengé Stained



RQ
Tinto Carbone \
Carbon Stained

Colonna e bordo base \

column and edge base

Metallo \ *Metal*

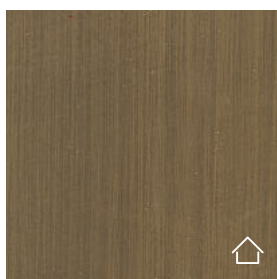

Ottone Brunito \
Bronzed Brass

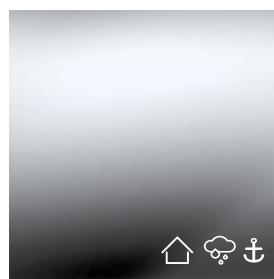

Inox Lucido Aisi 316 \
Inox Aisi 316 Polish

Collezione Diva \
Diva collection

Collezione di arredi composta da tavoli estensibili e contenitore. Tavolo estensibile a base centrale con struttura in rovere e metallo. Disponibile in versione tonda e ovale. Contenitore con due ante laterali curvate e sei cassetti centrali con sistema di apertura push&pull. Struttura in rovere. Basamento in massello di legno di rovere. Finiture di collezione.

Collection of furnishings composed of extendable tables and cabinet. Extendable table with central base and frame in oak and metal. Available in round and oval version. Cabinet with two curved side doors and six central drawers with push&pull opening system. Oak frame. Base in solid oak. Materials as per collection.

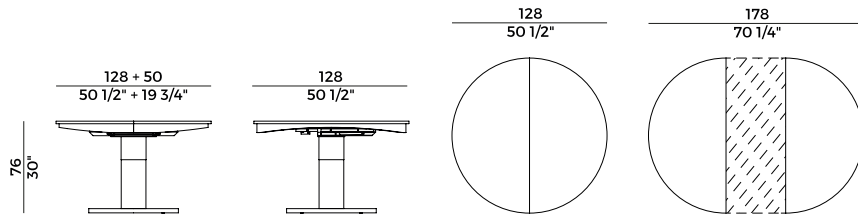

775/TC1
tavolo estensibile \ extendable table

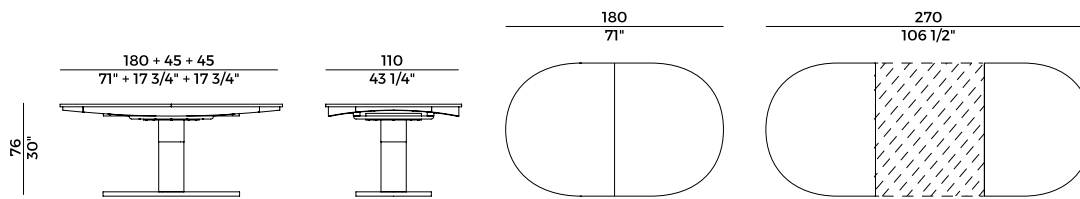

775/TO2
tavolo estensibile \ extendable table

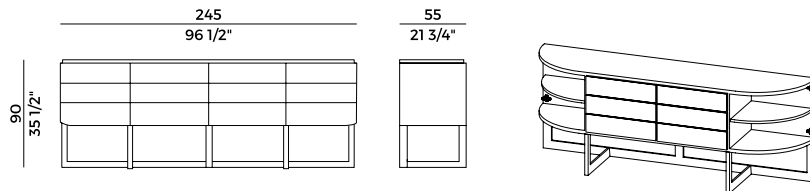

775/M
credenza \ sideboard