



**Cut, 910/PLG**  
**lounge girevole \**  
*swivel lounge armchair*

Cut nasce dalla volontà di sviluppare una seduta dalle forme ergonomiche e avvolgenti. Il risultato è una poltrona lounge dall'aspetto leggero ed estremamente confortevole, grazie anche ai cuscini di seduta e poggiatesta, sostenuta da un'essenziale base in alluminio verniciato nero gofrato, proposta in due versioni: fissa e a quattro razze. I profili netti e le cuciture a vista in corrispondenza delle incisioni conferiscono alla seduta un look tailor-made. Accompagna la poltrona lounge l'omonimo poggiapiedi, con base fissa e a quattro razze, che ne riprende le caratteristiche estetiche.

*Cut comes from the desire to create a seating with ergonomic and embracing, wrapping forms. The result is a lounge armchair with a light and extremely comfortable look, thanks also to its seat and headrest cushions, supported by an essential embossed black painted aluminum base, available in two versions: fixed and four-star base. The profiles and the visible stitching in correspondence of the incisions give the seat a tailor-made look. The homonymous footrest, available with a fixed or four-star base, accompanies the lounge armchair, which resumes its aesthetic characteristics.*

## Informazioni tecniche \ *Technical information*

### Descrizione tecnica \ *Technical description*



Poltrona lounge in versione girevole con base in alluminio verniciato nero goffrato. Imbottitura in poliuretano espanso ignifugo. Rivestimenti di collezione.

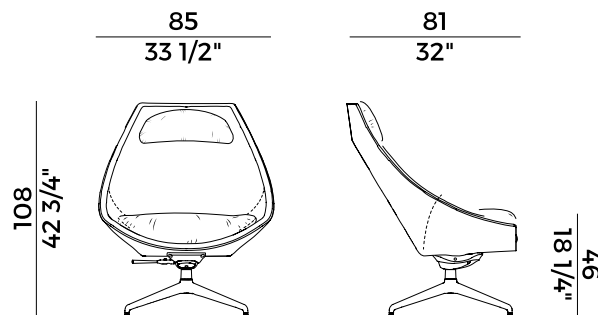

*Lounge armchair in the swivel version with base in embossed black painted aluminum. Padded in fire retardant polyurethane foam. Coverings as per collection.*

### Dimensioni \ *Dimensions*



### Consumi stoffe \ *Fabric and leather requirements*

FABRIC / LEATHER REQUIREMENTS			
		x1	x2
	<b>H 140</b>	ml 3,80	ml 7,60
	<b>LEATHER</b>	m <sup>2</sup> 8,50	

FABRIC / LEATHER REQUIREMENTS			
		x1	x2
	<b>H 140</b>	yd 4,20	yd 8,35
	<b>LEATHER</b>	ft <sup>2</sup> 92	

## Finiture \ *Finishes*

---

### Finiture struttura \

*Frame finishes*

### Alluminio \ *Aluminium*



Alluminio Nero Goffrato \  
Embossed Black Aluminium

### Rivestimenti \

*Coverings*

### Tessuto, ecopelle, pelle \ *Fabric, eco-leather, leather*

**Collezione Cut \**  
*Cut collection*

Poltrona lounge in versione girevole o fissa con base in alluminio verniciato nero goffrato.

Poggiapiedi con base in alluminio verniciato nero goffrato.

Imbottitura in poliuretano espanso ignifugo. Rivestimenti di collezione.

*Lounge armchair available in the swivel or fixed versions with base in embossed black painted aluminum.*

*Footrest with base in embossed black painted aluminum.*

*Padded in fire retardant polyurethane foam. Coverings as per collection.*

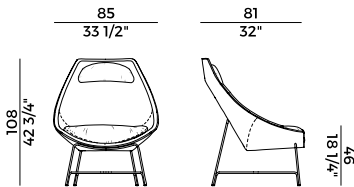

**910/PL**  
*lounge girevole \ swivel lounge armchair*

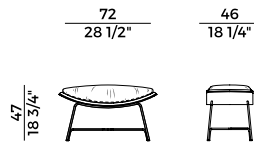

**910/PP**  
*poggiapiedi \ footrest*

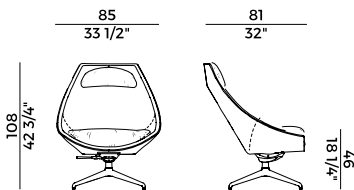

**910/PLG**  
*lounge girevole \ swivel lounge armchair*

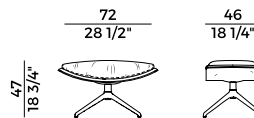

**910/PPG**  
*poggiapiedi \ footrest*



**Cut, 910/PPG**  
**poggiapiedi** \ *footrest*

Cut nasce dalla volontà di sviluppare una seduta dalle forme ergonomiche e avvolgenti. Il risultato è una poltrona lounge dall'aspetto leggero ed estremamente confortevole, grazie anche ai cuscini di seduta e poggiatesta, sostenuta da un'essenziale base in alluminio verniciato nero goffrato, proposta in due versioni: fissa e a quattro razze. I profili netti e le cuciture a vista in corrispondenza delle incisioni conferiscono alla seduta un look tailor-made. Accompagna la poltrona lounge l'omonimo poggiapiedi, con base fissa e a quattro razze, che ne riprende le caratteristiche estetiche.

*Cut comes from the desire to create a seating with ergonomic and embracing, wrapping forms. The result is a lounge armchair with a light and extremely comfortable look, thanks also to its seat and headrest cushions, supported by an essential embossed black painted aluminum base, available in two versions: fixed and four-star base. The profiles and the visible stitching in correspondence of the incisions give the seat a tailor-made look. The homonymous footrest, available with a fixed or four-star base, accompanies the lounge armchair, which resumes its aesthetic characteristics.*

## Informazioni tecniche \ *Technical information*

### Descrizione tecnica \ *Technical description*



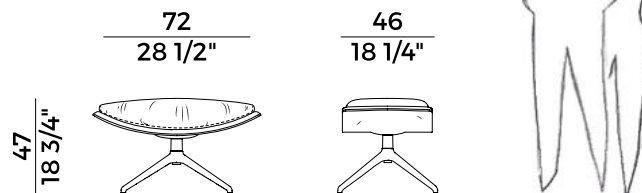

Poggiapiedi con base in alluminio verniciato nero goffrato. Imbottitura in poliuretano espanso ignifugo. Rivestimenti di collezione.

*Footrest with base in embossed black painted aluminum. Padded in fire retardant polyurethane foam. Coverings as per collection.*

### Dimensioni \ *Dimensions*



### Consumi stoffe \ *Fabric and leather requirements*

FABRIC / LEATHER REQUIREMENTS				FABRIC / LEATHER REQUIREMENTS			
		x1	x2			x1	x2
	<b>H 140</b>	ml 1,50	ml 3,00		<b>H 140</b>	yd 1,65	yd 3,30
	<b>LEATHER</b>	m <sup>2</sup> 2,90			<b>LEATHER</b>	ft <sup>2</sup> 32	

## Finiture \ *Finishes*

---

### Finiture struttura \

*Frame finishes*

### Alluminio \ *Aluminium*



Nero Goffrato \  
Embossed Black

### Rivestimenti \

*Coverings*

### Tessuto, ecopelle, pelle \ *Fabric, eco-leather, leather*

**Collezione Cut \**  
*Cut collection*

Poltrona lounge in versione girevole o fissa con base in alluminio verniciato nero goffrato.

Poggiapiedi con base in alluminio verniciato nero goffrato.

Imbottitura in poliuretano espanso ignifugo. Rivestimenti di collezione.

*Lounge armchair available in the swivel or fixed versions with base in embossed black painted aluminum.*

*Footrest with base in embossed black painted aluminum.*

*Padded in fire retardant polyurethane foam. Coverings as per collection.*

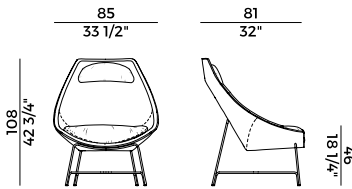

**910/PL**  
*lounge girevole \ swivel lounge armchair*

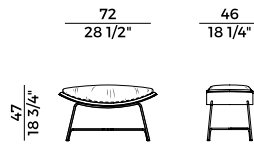

**910/PP**  
*poggiapiedi \ footrest*

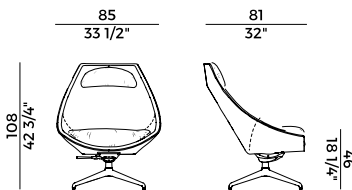

**910/PLG**  
*lounge girevole \ swivel lounge armchair*

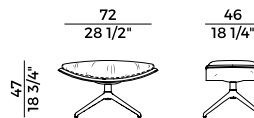

**910/PPG**  
*poggiapiedi \ footrest*





**Cut, 910/PL**  
poltrona lounge \ lounge armchair

Cut nasce dalla volontà di sviluppare una seduta dalle forme ergonomiche e avvolgenti. Il risultato è una poltrona lounge dall'aspetto leggero ed estremamente confortevole, grazie anche ai cuscini di seduta e poggiatesta, sostenuta da un'essenziale base in alluminio verniciato nero gofrato, proposta in due versioni: fissa e a quattro razze. I profili netti e le cuciture a vista in corrispondenza delle incisioni conferiscono alla seduta un look tailor-made. Accompagna la poltrona lounge l'omonimo poggiapiedi, con base fissa e a quattro razze, che ne riprende le caratteristiche estetiche.

*Cut comes from the desire to create a seating with ergonomic and embracing, wrapping forms. The result is a lounge armchair with a light and extremely comfortable look, thanks also to its seat and headrest cushions, supported by an essential embossed black painted aluminum base, available in two versions: fixed and four-star base. The profiles and the visible stitching in correspondence of the incisions give the seat a tailor-made look. The homonymous footrest, available with a fixed or four-star base, accompanies the lounge armchair, which resumes its aesthetic characteristics.*

## Informazioni tecniche \ *Technical information*

### Descrizione tecnica \ *Technical description*



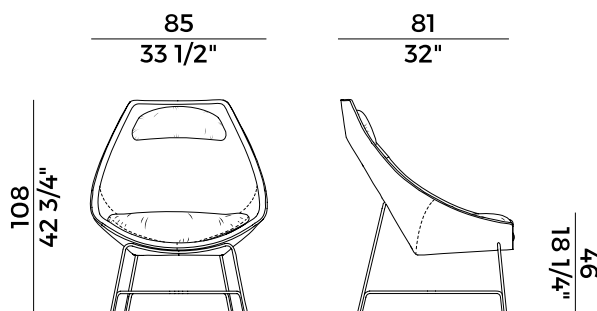

Poltrona lounge in versione fissa con base in alluminio verniciato nero goffrato. Imbottitura in poliuretano espanso ignifugo. Rivestimenti di collezione.

*Lounge armchair in the fixed version with base in embossed black painted aluminum. Padded in fire retardant polyurethane foam. Coverings as per collection.*

### Dimensioni \ *Dimensions*



### Consumi stoffe \ *Fabric and leather requirements*

FABRIC / LEATHER REQUIREMENTS				FABRIC / LEATHER REQUIREMENTS			
		x1	x2			x1	x2
	<b>H 140</b>	ml 3,80	ml 7,60		<b>H 140</b>	yd 4,20	yd 8,35
	<b>LEATHER</b>	m <sup>2</sup> 8,50			<b>LEATHER</b>	ft <sup>2</sup> 92	

## Finiture \ *Finishes*

---

### Finiture struttura \

*Frame finishes*

### Alluminio \ *Aluminium*

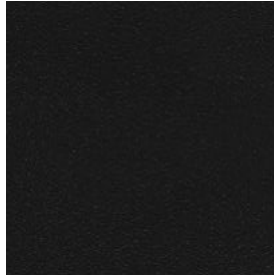

Alluminio Nero Goffrato \  
Embossed Black Aluminium

### Rivestimenti \

*Coverings*

### Tessuto, ecopelle, pelle \ *Fabric, eco-leather, leather*

**Collezione Cut \**  
*Cut collection*

Poltrona lounge in versione girevole o fissa con base in alluminio verniciato nero goffrato.

Poggiapiedi con base in alluminio verniciato nero goffrato.

Imbottitura in poliuretano espanso ignifugo. Rivestimenti di collezione.

*Lounge armchair available in the swivel or fixed versions with base in embossed black painted aluminum.*

*Footrest with base in embossed black painted aluminum.*

*Padded in fire retardant polyurethane foam. Coverings as per collection.*

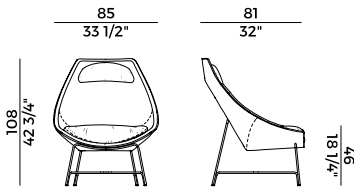

**910/PL**  
*lounge girevole \ swivel lounge armchair*

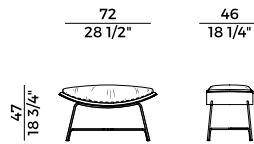

**910/PP**  
*poggiapiedi \ footrest*

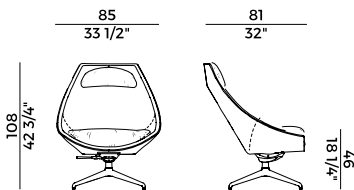

**910/PLG**  
*lounge girevole \ swivel lounge armchair*

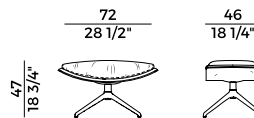

**910/PPG**  
*poggiapiedi \ footrest*



**Cut, 910/PP**  
**poggiapiedi** \ *footrest*

Cut nasce dalla volontà di sviluppare una seduta dalle forme ergonomiche e avvolgenti. Il risultato è una poltrona lounge dall'aspetto leggero ed estremamente confortevole, grazie anche ai cuscini di seduta e poggiatesta, sostenuta da un'essenziale base in alluminio verniciato nero gofrato, proposta in due versioni: fissa e a quattro razze. I profili netti e le cuciture a vista in corrispondenza delle incisioni conferiscono alla seduta un look tailor-made. Accompagna la poltrona lounge l'omonimo poggiapiedi, con base fissa e a quattro razze, che ne riprende le caratteristiche estetiche.

*Cut comes from the desire to create a seating with ergonomic and embracing, wrapping forms. The result is a lounge armchair with a light and extremely comfortable look, thanks also to its seat and headrest cushions, supported by an essential embossed black painted aluminum base, available in two versions: fixed and four-star base. The profiles and the visible stitching in correspondence of the incisions give the seat a tailor-made look. The homonymous footrest, available with a fixed or four-star base, accompanies the lounge armchair, which resumes its aesthetic characteristics.*

## Informazioni tecniche \ *Technical information*

### Descrizione tecnica \ *Technical description*



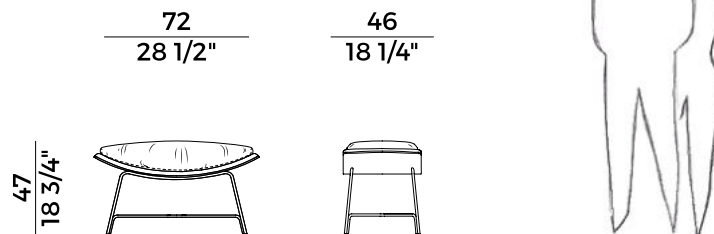

Poggiapiedi con base in alluminio verniciato nero goffrato. Imbottitura in poliuretano espanso ignifugo. Rivestimenti di collezione.

*Footrest with base in embossed black painted aluminum. Padded in fire retardant polyurethane foam. Coverings as per collection.*

### Dimensioni \ *Dimensions*



### Consumi stoffe \ *Fabric and leather requirements*

FABRIC / LEATHER REQUIREMENTS				FABRIC / LEATHER REQUIREMENTS			
		x1	x2			x1	x2
	<b>H 140</b>	ml 1,50	ml 3,00		<b>H 140</b>	yd 1,65	yd 3,30
	<b>LEATHER</b>	m <sup>2</sup> 2,90			<b>LEATHER</b>	ft <sup>2</sup> 32	

## Finiture \ *Finishes*

---

### Finiture struttura \

*Frame finishes*

### Alluminio \ *Aluminium*



Alluminio Nero Goffrato \  
Embossed Black Aluminium

### Rivestimenti \

*Coverings*

### Tessuto, ecopelle, pelle \ *Fabric, eco-leather, leather*

**Collezione Cut \**  
*Cut collection*

Poltrona lounge in versione girevole o fissa con base in alluminio verniciato nero goffrato.

Poggiapiedi con base in alluminio verniciato nero goffrato.

Imbottitura in poliuretano espanso ignifugo. Rivestimenti di collezione.

*Lounge armchair available in the swivel or fixed versions with base in embossed black painted aluminum.*

*Footrest with base in embossed black painted aluminum.*

*Padded in fire retardant polyurethane foam. Coverings as per collection.*

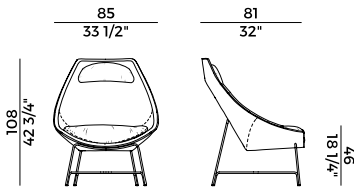

**910/PL**  
*lounge girevole \ swivel lounge armchair*

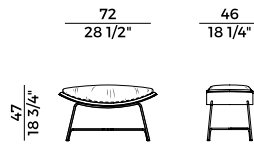

**910/PP**  
*poggiapiedi \ footrest*

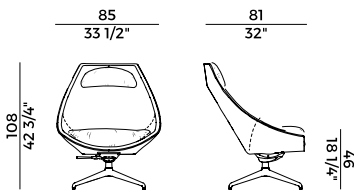

**910/PLG**  
*lounge girevole \ swivel lounge armchair*

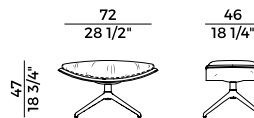

**910/PPG**  
*poggiapiedi \ footrest*