

CUBE OUTDOOR

Massimiliano Raggi



SMALL

LARGE



Incarnazione della filosofia di Contardi di portare l'interior design all'esterno, per un outdoor funzionale e di classe. Il modello Cube diventa oggi lanterna da esterno in versione a batteria ricaricabile o cablata. Nel modello a batteria presentiamo un nuovo ed innovativo sistema di accensione, senza interruttore: il solo posizionamento del corpo batteria sul supporto permette l'accensione automatica con una lieve rotazione. Per la ricarica non occorre spostare tutto il prodotto, ma è sufficiente rimuovere il corpo batteria e collegarlo alla corrente. Disponibile con interno oro satinato ed esterno laccato effetto bronzo scuro oppure tutta in bianco (interno ed esterno).

The incarnation of Contardi's philosophy of bringing the interior design to the outside for functional and classy outdoor. Cube now becomes an outdoor lantern in a rechargeable or wired battery version. To switch on the Battery version, it is enough a slight rotation of the light cylinder. It is not necessary to move the entire product for charging, but you just need to remove the battery pack and connect it to the power supply. Available with satin gold interior and dark bronze lacquered effect exterior or all in white (interior and exterior).

SPECIFICHE PRODOTTO / PRODUCT SPECIFCS

p2

CUBE OUTDOOR SMALL
CUBE OUTDOOR LARGE

p4
p5

CUBE OUTDOOR BATTERY SMALL
CUBE OUTDOOR BATTERY LARGE

p6
p7



STRUTTURA / FRAME

Esterno: bronzo scuro
Outside: dark bronze



Laccato bianco opaco,
trattamento cataforesi Marine Grade
*Matt white lacquered, Marine
Grade with cataphoresis treatment*



Interno: laccato oro, trattamento
cataforesi Marine Grade
*Inside: gold lacquered, Marine
Grade with cataphoresis
treatment*

DIFFUSORE / DIFFUSER

Versione CABLATA
Vetro satinato
*WIRED version
Frosted glass*

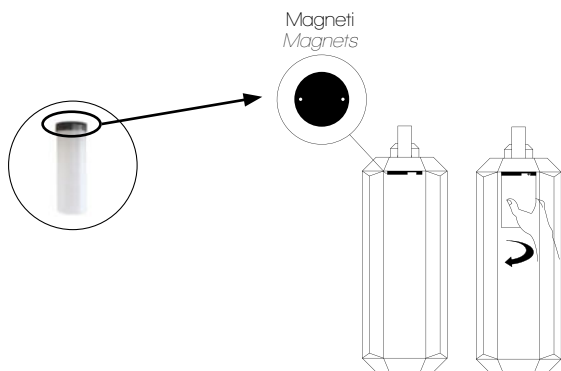

Versione BATTERIA
Plexiglass satinato
*BATTERY version
Satin plexiglass*

**ACCENSIONE / SPEGNIMENTO
SWITCHING ON / OFF****NOTE:**

1. VERSIONE CABLATA: fornita solo con connettore IP68. In caso di collegamento con spina, il grado di protezione passa da IP65 a IP44.
2. VERSIONE BATTERIA: Ruotare la parte luminosa fino al primo scatto. Il primo scatto è la posizione "spento". Ruotare fino a fine corsa in posizione di estrazione. Sganciare e tirare verso di se il blocco luminoso, che si staccherà facilmente dalla base. Inserire il caricatore nella presa elettrica e posizionare l'estremità magnetica del cavo su quello del corpo luminoso.

NOTES:

1. WIRED VERSION: supplied only with IP68 connector. In case of connection with a plug, the protection degree changes from IP65 to IP44.
2. BATTERY VERSION: Rotate the luminous part up to the first click. The first shot is the "off" position. Rotate all the way to the extraction position. Unhook and pull the luminous block towards you, which will come off easily from the base. Insert the charger into the electrical socket and place the magnetic end of the cable on that of the luminous body.

**CAVO / CABLE**

Cavo nero
Connettore IP68 per esterni

*Black cable
IP68 outdoor connector
L: 200 cm
L: 78.7"*

**FRONTE LUMINOSA / LIGHT SOURCE**

Versione CABLATA
WIRED version



E27 T8 Tubular LED
Utilizzabili lampadine LED fino
alla massima potenza disponibile
sul mercato

*You can use LED light bulbs of
the highest available wattage*

H max. 14,5 cm / 5.7"

**SMALL / LARGE**

1 X E27 T8
Lampadina Tubolar LED
Tubular LED bulb

Versione BATTERIA
BATTERY version



Custom LED
IP65
Autonomia: 9/10 ore
Cicli di vita: 600
Tempi di ricarica: 4 ore
Fornita con caricabatterie

*Autonomy: 9/10 hours
Lifestyle cycles: 600
Charging time: about 4 hours
Supplied with battery charger*

**SMALL BATTERY / LARGE BATTERY**

1 X 3W
Lumen: 400
2.700 K; CRI: >90



Cube Outdoor SMALL & LARGE

USA / LIGHT SOURCE

WIRED version



E26 T8 Tubular LED

You can use LED light bulbs of
the highest available wattage

H max. 14,5 cm / 5.7"

**SMALL / LARGE**

1 X E26 T8
Tubular LED bulb

BATTERY version



Custom LED
IP65
Autonomy: 9/10 hours
Lifestyle cycles: 600
Charging time: about 4 hours
Supplied with battery charger

**SMALL BATTERY / LARGE BATTERY**

1 X 3W
Lumen: 400
2.700 K; CRI: >90

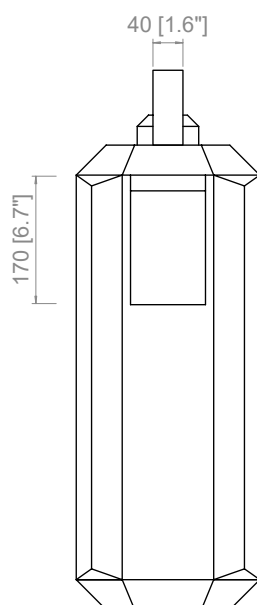
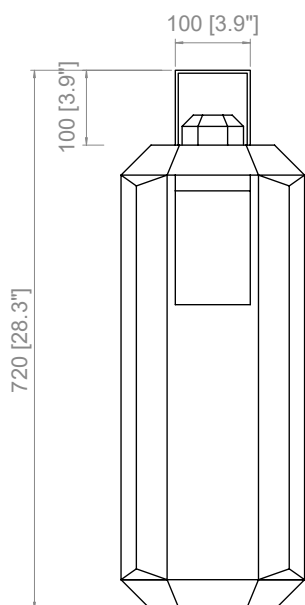
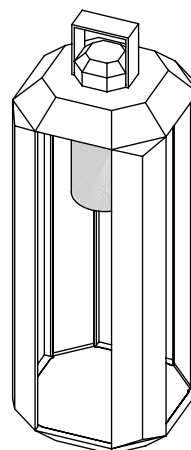
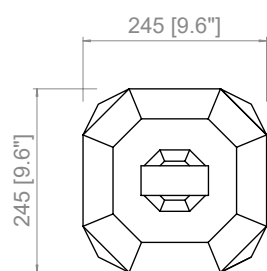

PRODOTTO / PRODUCT

PESO / WEIGHT
5 kg / 11 lbs

BOX 1

L: 34 cm / 13.4"
W: 34 cm / 13.4"
H: 86 cm / 33.8"

PESO / WEIGHT
6 kg / 13.2 lbs

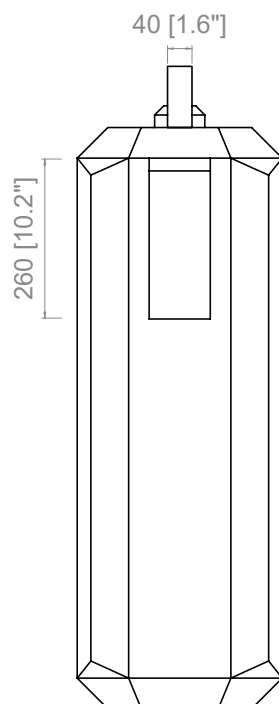
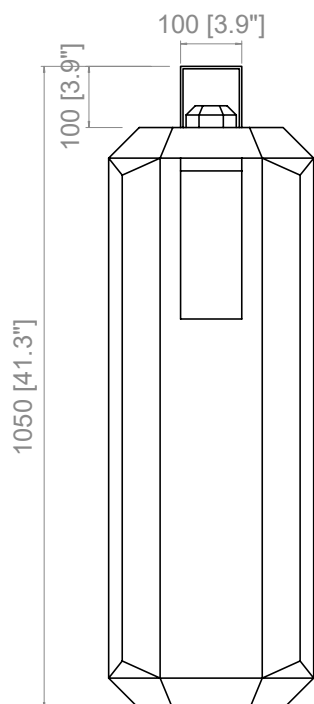
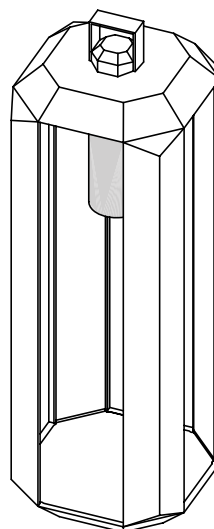
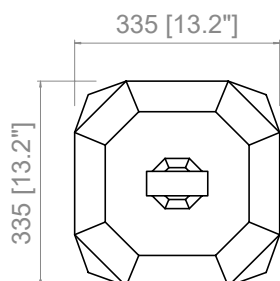

PRODOTTO / PRODUCT

BOX 1

PESO / WEIGHT
17 kg / 37.4 lbs

L: 47 cm / 18.5"
W: 47 cm / 18.5"
H: 121 cm / 47.6"

PESO / WEIGHT
18 kg / 39.6 lbs

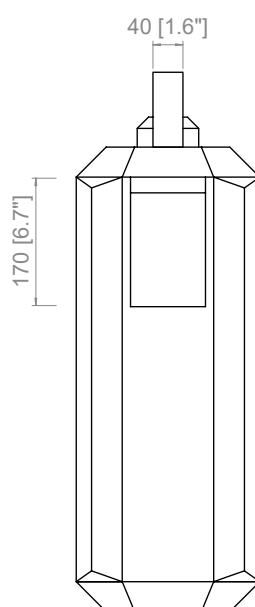
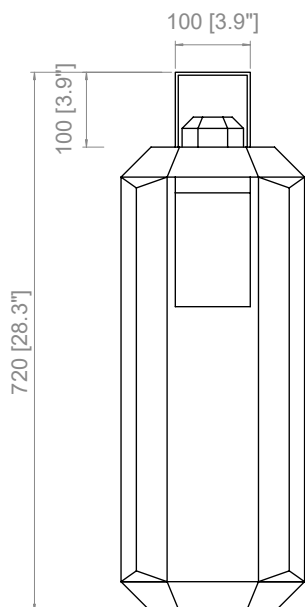
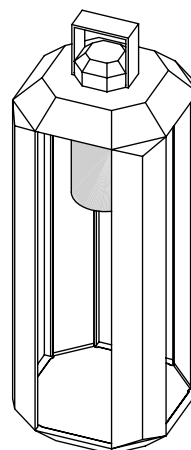
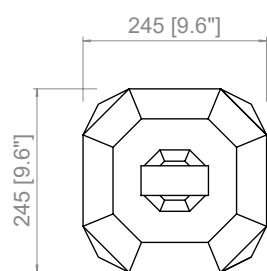

PRODOTTO / PRODUCT

PESO / WEIGHT
5 kg / 11 lbs

BOX 1

L: 34 cm / 13.4"
W: 34 cm / 13.4"
H: 86 cm / 33.8"

PESO / WEIGHT
6 kg / 13.2 lbs

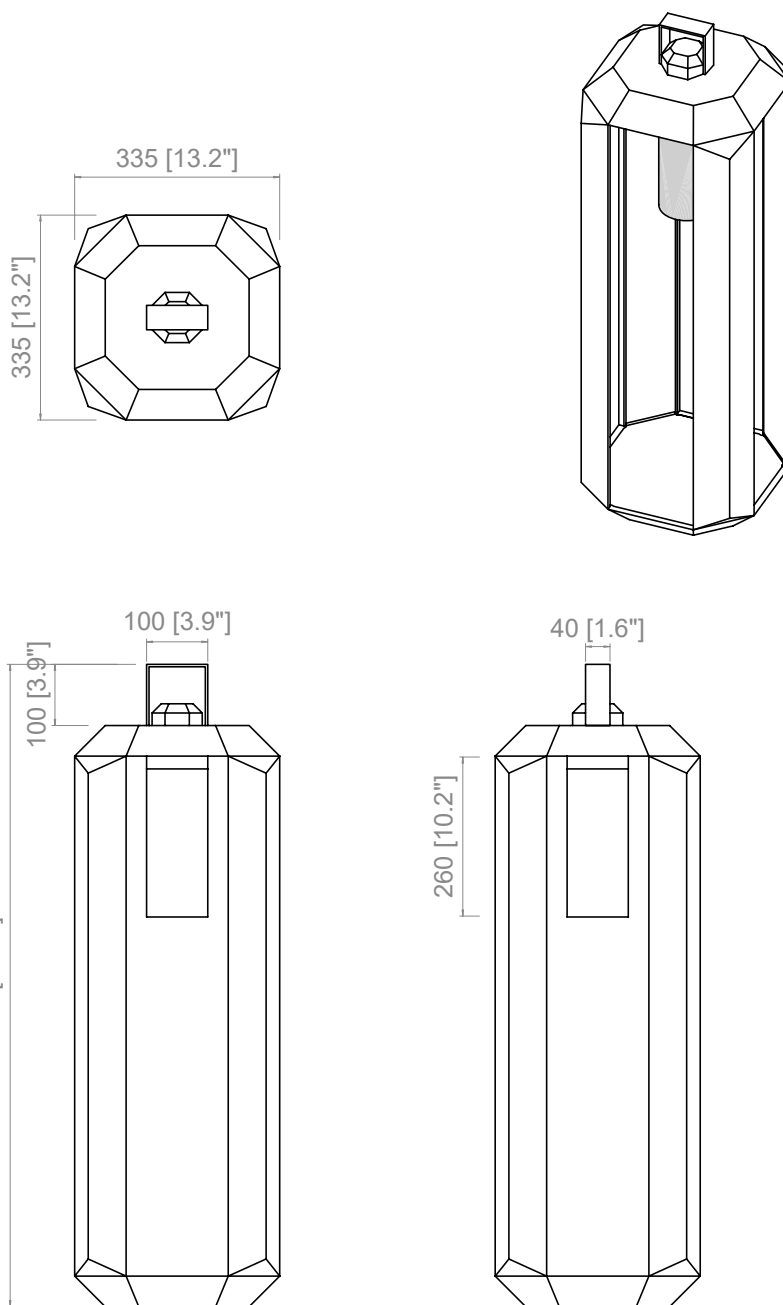

PRODOTTO / PRODUCT

BOX 1

PESO / WEIGHT
17 kg / 37.4 lbs

L: 47 cm / 18.5"
W: 47 cm / 18.5"
H: 121 cm / 47.6"

PESO / WEIGHT
18 kg / 39.6 lbs



Copyright and/or design rights subsist in this drawing. No part of this drawing may be reproduced in any material form (including photocopying or storing in any medium electronic means, whether or not intentionally and whether or not as part or a larger publication) without the express permission of the copyright owner, Contardi Lighting S.r.l.. Further and without prejudice to the above, this drawing and all information relating thereto is confidential, and shall not be communicated to a third party without the consent of Contardi lighting srl. Contardi lighting srl asserts all rights to be identified as the author of the work and otherwise.

WARNING: The doing of any unauthorised act in relation to a copyright work may result in both a civil claim for damages and criminal prosecution.

CONTARDI LIGHTING Srl

ITALY HEADQUARTERS

www.contardi-italia.com / sales@contardi-italia.it

CONTARDI USA Inc

USA BRANCH

www.contardi-usa.com / sales@contardi-usa.com

