

ARCIPELAGO

Servomuto



SO



TA



La collezione Arcipelago è composta da lampade sospese e da tavolo. Disponibili in due forme denominate Maiorca e Minorca, caratterizzate dal paralume a frange in trevira CS ignifugo e la struttura in vero ottone satinato, dettagli che impreziosiscono il prodotto. La fonte luminosa è una piastra LED customizzata e dimmerabile, che nella versione da tavolo si regola mediante pulsante a tre intensità sulla base.

Arcipelago collection is composed by hanging and table lights. Available in two shapes called Maiorca and Minorca, characterised by the shade made out of the fire-resistant Trevira CS fringes and the body in real satin brass, details that enrich the product. The light source is a customized dimmable LED board, which, in the table version, can be regulated through a three-phase dimmer switch positioned on the base.

SPECIFICHE PRODOTTO / PRODUCT SPECIFCS

p2

ARCIPELAGO SO MAIORCA
ARCIPELAGO SO MINORCA

p3
p4

ARCIPELAGO TA MAIORCA
ARCIPELAGO TA MINORCA

p5
p6

**STRUTTURA / FRAME**

Finitura ottone satinato
Satin brass finish

FRANGE / FRINGES

Franghe verde salvia
"Sage green colour" fringes



Franghe ruggine
"Rust colour" fringes



Franghe cognac
"Cognac colour" fringes



Franghe sabbia
"Sand colour" fringes



Franghe aragosta
"Aragosta" (bright orange) fringes



Franghe blu nebbia
"Fog blue colour" fringes

NOTE:

1. Franghe ignifughe: CLASSE UNO IM - BS EN 1021.1:2006 CIGARETTE TEST - BS EN 1021.2:2006 BUTANE FLAME TEST - NPFA 280:CLASS 1 IMO A0652(16) - CIGARETTE TEST AND BUTANE TEST
2. Le franghe del modello Arcipelago sono lavabili. Conservare il sacchetto per il lavaggio. Immergere, dentro il sacchetto, le franghe in acqua a 30° e detersivo. Sciacquare sotto acqua corrente. Appendere ancora bagnato. Nel caso le franghe si accorcino dopo il lavaggio, stirare con ferro tiepido (temperatura per seta).
3. Utilizzare un panno asciutto per pulire la struttura della lampada.

NOTES:

1. Fire-resistant fringes: CLASSE UNO IM - BS EN 1021.1:2006 CIGARETTE TEST - BS EN 1021.2:2006 BUTANE FLAME TEST - NPFA 280:CLASS 1 IMO A0652(16) - CIGARETTE TEST AND BUTANE TEST
2. The fringes of the model Arcipelago are washable. Keep the bag for washing. Immerse the fringes inside the bag in water and clean it at the temperature of 30°C. Rinse with flowing water. Hang while still wet. In case the fringes get shorter after washing, iron with warm iron (use the temperature for silk).
3. Use a dry cloth to clean the frame of the lamp.

CAVO - INTERRUPTORE / CABLE - SWITCH

Tessuto nero
Black fabric

TA
Pulsante a tre intensità sulla base
Three step push switch on the base
H: 200 cm
H: 78.7"

SO
L: 200 cm
L: 78.7"

FONTE LUMINOSA / LIGHT SOURCE

 Custom LED
1 X 18W
Custom LED
Lumen: 1.800
3.000 K; CRI: >90

DIMMERABILE / DIMMABLE

TA
Tre livelli di intensità (100 - 70 - 30%)
Three intensity levels (100 - 70 - 30%)

SO
Compatibili con sistemi di controllo remoto
Compatible with remote control systems



 Arcipelago TA e SO

USA / CABLE - SWITCH

Black cable

TA
Three step push switch on the base
H: 78.7"

SO
L: 78.7"

USA / LIGHT SOURCE

 Custom LED
1 X 18W
Custom LED
Lumen: 1.800
3.000 K; CRI: >90

DIMMABLE

TA
Three intensity levels (100 - 70 - 30%)

SO
Compatible with remote control systems

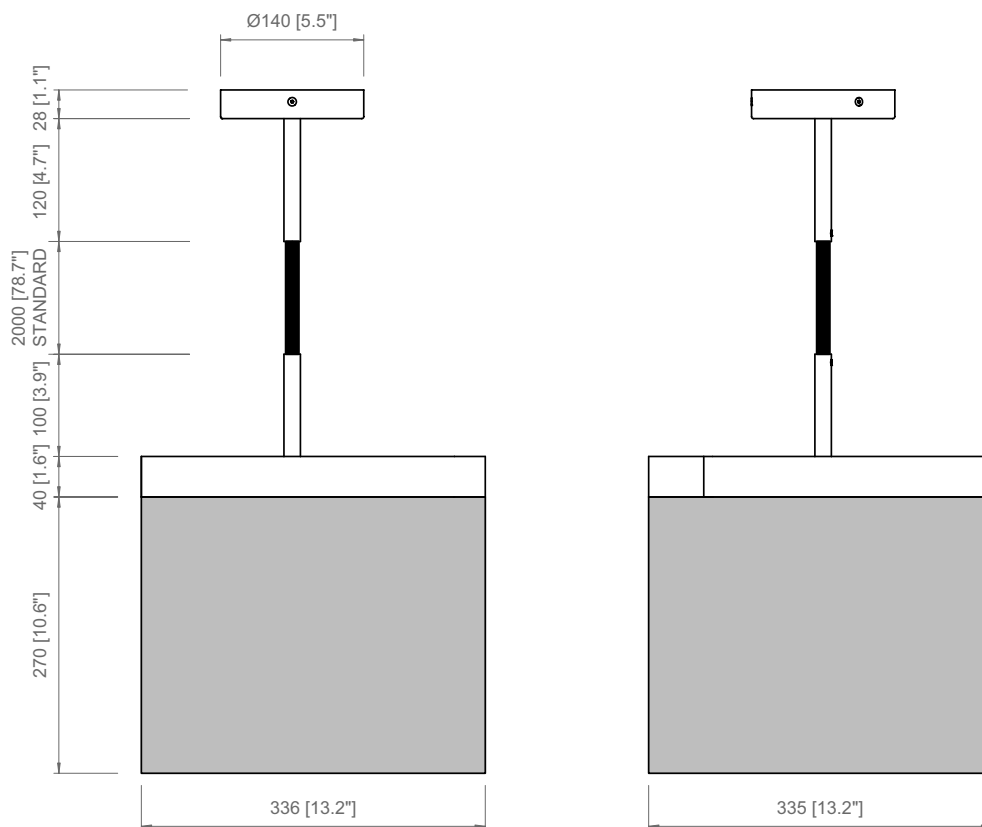
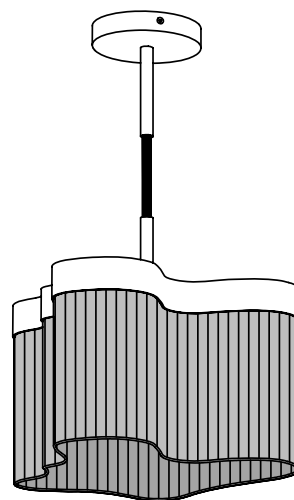
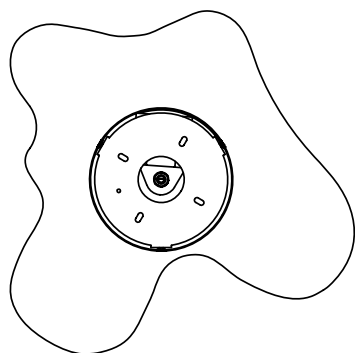

PRODOTTO / PRODUCT

PESO / WEIGHT
4,3 kg / 11 lbs

BOX 1

L: 38 cm / 16.5"
W: 42 cm / 16"
H: 48 cm / 18.9"

PESO / WEIGHT
5 kg / 13.2 lbs

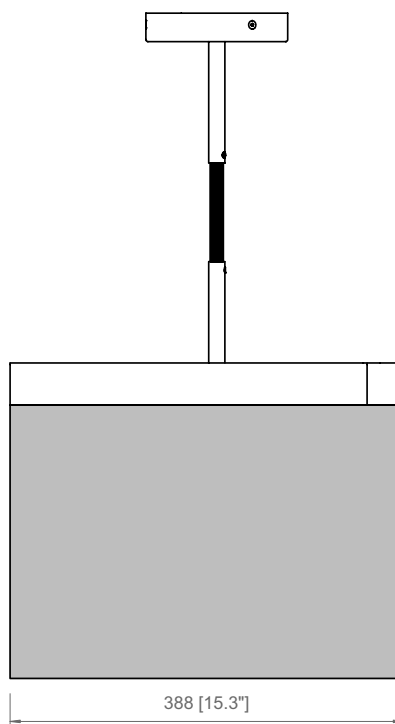
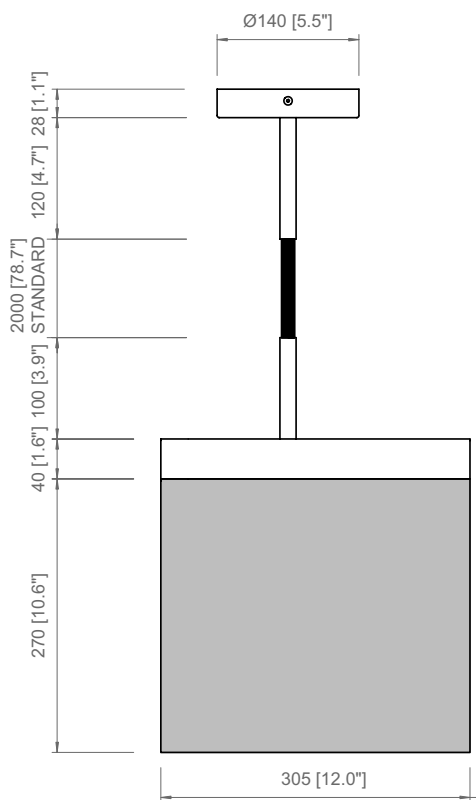
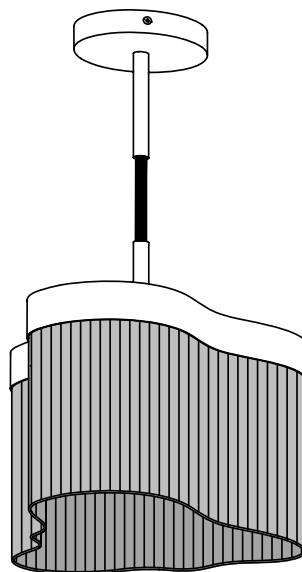
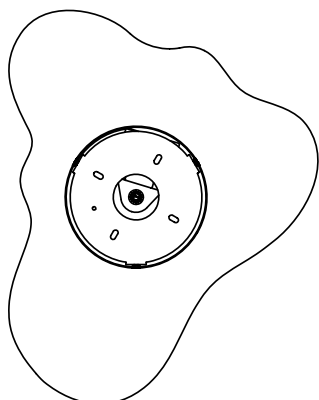

PRODOTTO / PRODUCT

PESO / WEIGHT
4,3 kg / 11 lbs

BOX 1

L: 38 cm / 16.5"
W: 42 cm / 16"
H: 48 cm / 18.9"

PESO / WEIGHT
5 kg / 13.2 lbs

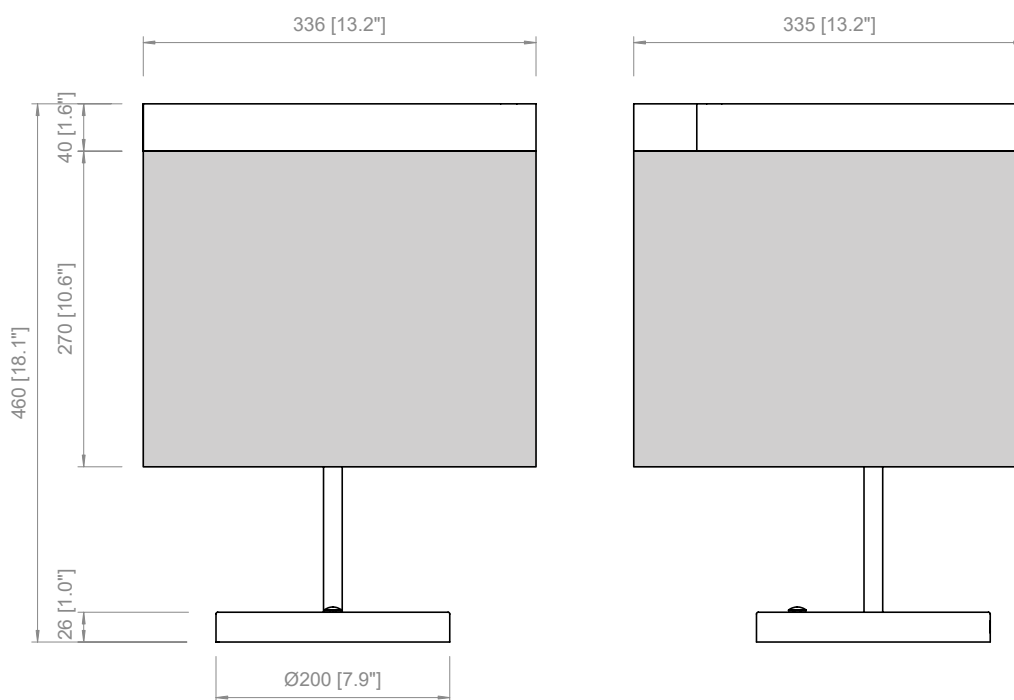
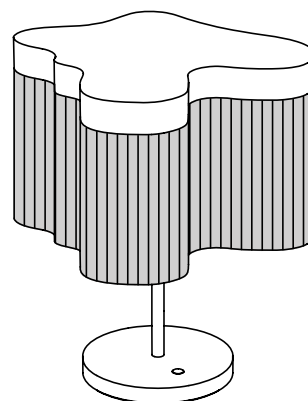
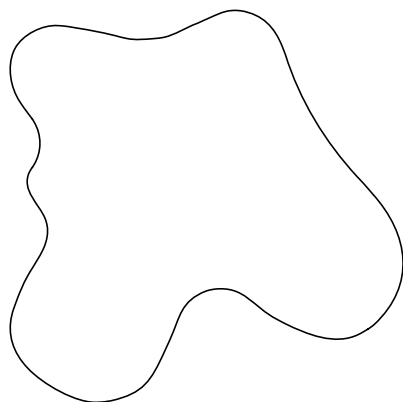

PRODOTTO / PRODUCT

PESO / WEIGHT
5,5 kg / 15.4 lbs

BOX 1

L: 41 cm / 16.1"
W: 41 cm / 16.1"
H: 61 cm / 24"

PESO / WEIGHT
7 kg / 17.6 lbs

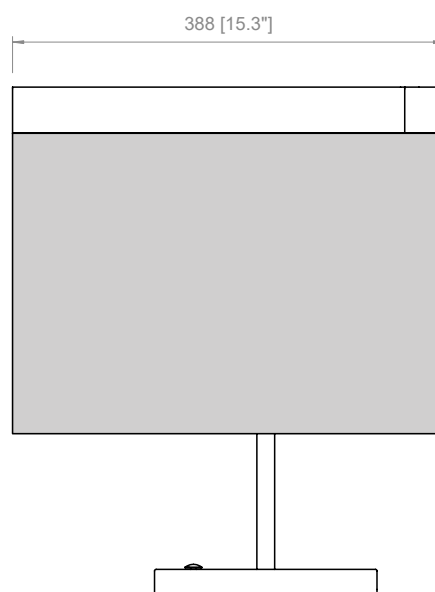
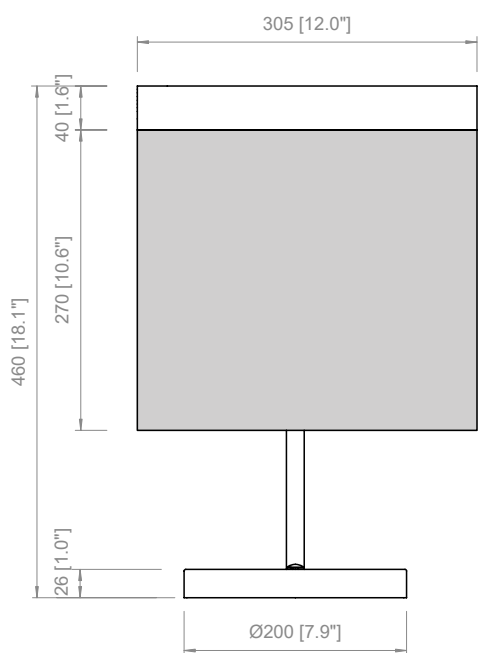
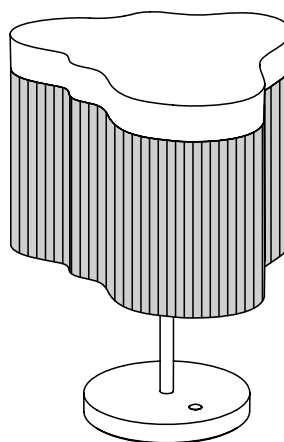
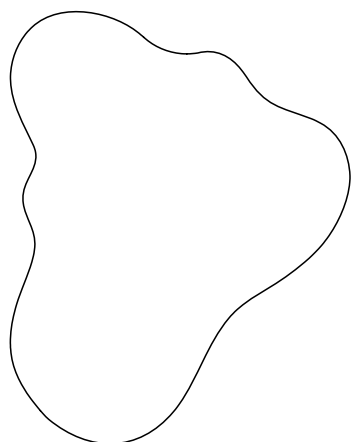

PRODOTTO / PRODUCT

PESO / WEIGHT
5,5 kg / 15.4 lbs

BOX 1

L: 41 cm / 16.1"
W: 41 cm / 16.1"
H: 61 cm / 24"

PESO / WEIGHT
7 kg / 17.6 lbs



Copyright and/or design rights subsist in this drawing. No part of this drawing may be reproduced in any material form (including photocopying or storing in any medium electronic means, whether or not intentionally and whether or not as part or a larger publication) without the express permission of the copyright owner, Contardi Lighting S.r.l.. Further and without prejudice to the above, this drawing and all information relating thereto is confidential, and shall not be communicated to a third party without the consent of Contardi lighting srl. Contardi lighting srl asserts all rights to be identified as the author of the work and otherwise.

WARNING: The doing of any unauthorised act in relation to a copyright work may result in both a civil claim for damages and criminal prosecution.

CONTARDI LIGHTING Srl

ITALY HEADQUARTERS

www.contardi-italia.com / sales@contardi-italia.it

CONTARDI USA Inc

USA BRANCH

www.contardi-usa.com / sales@contardi-usa.com

